

OPERATOR'S MANUAL AND PARTS LIST

**MUBEA Hydraulically Powered Flat bar, Section and Bar Shears
with Coper-Notcher and Punch**

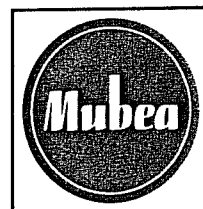

MODEL: KBLH 500

Serial Number:

Motor Type:

Motor Rating:

Operating Voltage:

OPERATOR'S MANUAL

Page

Guards	3
General	5
Transport and Installation	6
Connection and Starting	7
Lubrication	8
Engagement	9 – 10
Flat Bar Shear	11 – 14
Coper-Notcher	15 – 17
Section Shear	19 – 31
Punch	33 – 42
Maintenance Description for Hydraulic Plant	43 – 48
Lubrication Chart	
Foundation Plan	

PARTS LIST

Assembly

Assembly

Machine body, complete	01560 001 00	Hold-down, plate shear, complete	01560 063 00
Shear slide and shear cylinder, complete	01560 031 00	Stripper, complete	01561 065 00
Punch slide and punch cylinder, complete	01560 034 00	Support table, complete	01560 066 00
Electric foot engagement, shear, complete	01560 046 00	Electric system, complete	01561 071 00
Electric foot engagement, punch, complete	01560 047 00	Switch cabinet, complete	01563 071 01
Non deform blade, complete	01560 051 00	Hand Lubrication, complete	01560 081 00
Rectangular coper and guard, complete	01560 053 00	Hydraulic station, complete	01561 083 00
Triangular notcher and guard, complete	01560 054 00	Hoses, complete	01560 084 00
Section and bar shear knives, complete	01561 056 00	Guard, complete	01560 091 00
PMG section knife, complete	01560 057 00	Movable guard, plate shear, complete	01560 095 00
Punch tool, complete	01561 059 00	Movable guard, section shear, complete	01560 096 00
		Accessories, complete	01562 102 00
		Support bracket for coper-notcher saddle, complete	01560 125 00



Muhr und Bender
Maschinenbau GmbH
Postfach 340
DE 57427 Attendorn

Your MUBEA machine is in accordance with the rules for prevention of accidents and the machine protection law.

To ensure safe operation all working stations have been provided with suitable guards.

To avoid detracton from their very functions these guards are not shown on the illustrations of the single working stations.

USE ONLY THOSE PUNCHING DEVICES AND TOOLS WHICH ARE SUFFICIENTLY GUARDED TO AVOID FINGER INJURY.

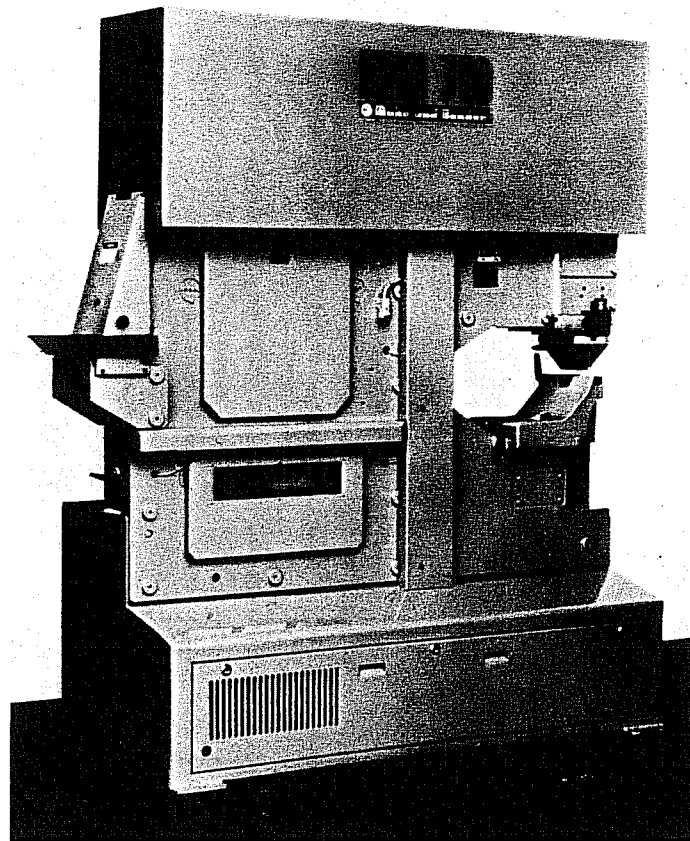

Guards on discharge side for section and flat steel shear

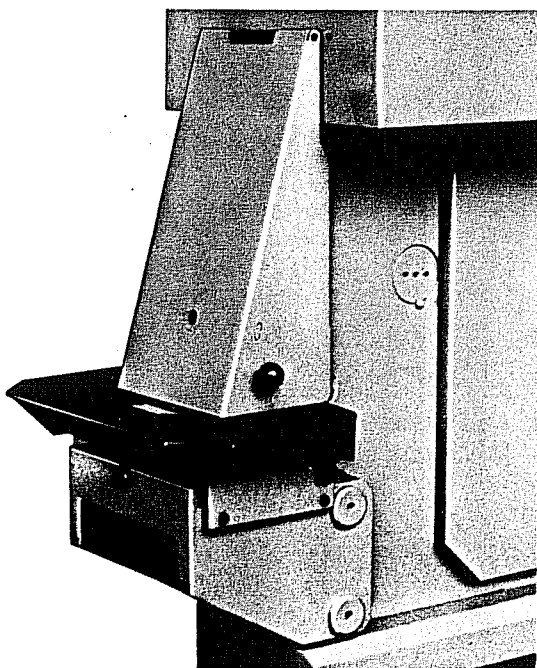

Guard-notching tool

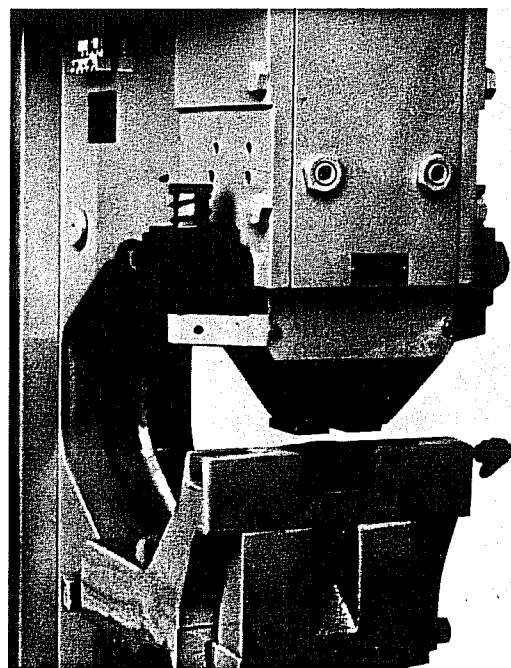

Guard-punching tool

GENERAL

As you will soon confirm, you have made a good choice. Decades of experience and latest findings and trends in punch and shear construction have been considered in developing this MUBEA machine. As many satisfied customers have been confirming, it is just the daily handling of this machine which shows its outstanding advantages. To make optimum use of this machine, please study and thoroughly mind the following operating instructions.

Experience has shown that the machine is of very long service life. Parts being subject to normal wear can be replaced at any time. It is very important that you order original MUBEA spare parts only, for thus the required service life and the steady first-class working quality will be reached. This also applies, if you intend to extend the application range of your machine by using additional tools.

Shop practice will soon convince you that just MUBEA machines can effectively be completed and are universally usable and efficient.

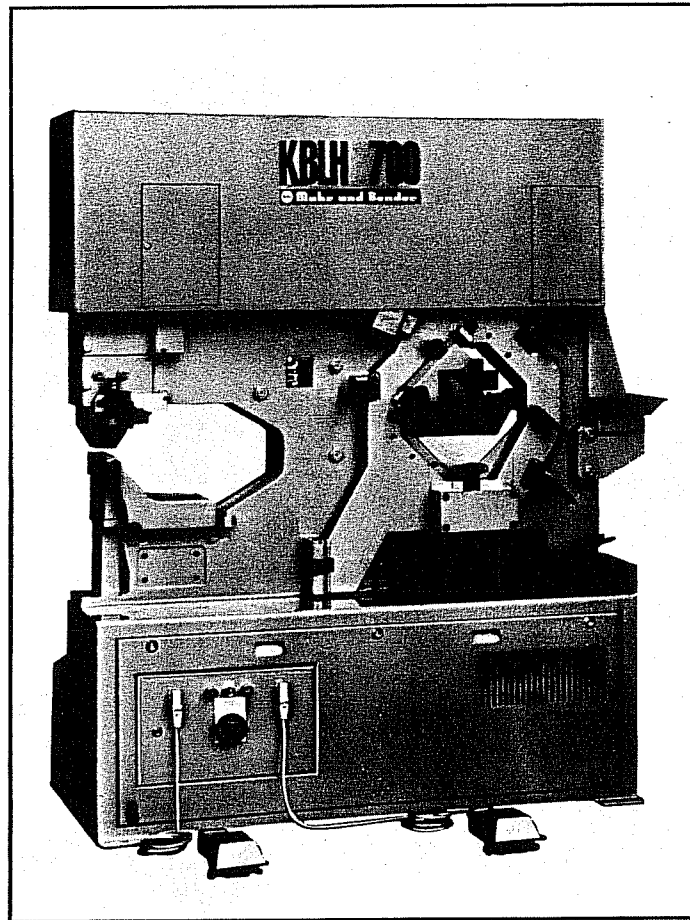

To give you a general idea of the single components of the machine and their interactions, please study the detailed survey of all parts and their article numbers given at the end of these instructions.

And just another important thing: Keep the machine always in the good condition it deserves. Adequate hints can be learned from the following operating instructions.

TRANSPORT

For transport by truck, stabilize, and screw the machine to solid planks.

For transport by crane, hook the machine into the ring bolt provided.

As to the weight of your machine, please confer the leaflet enclosed.

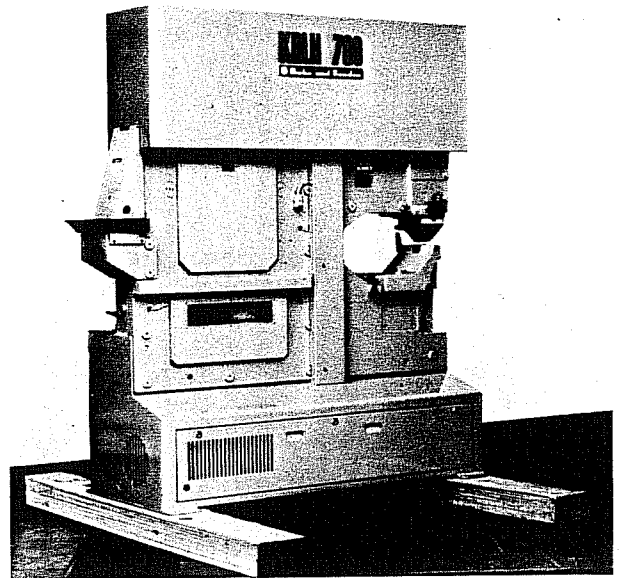

Fig. 1: Transport by truck

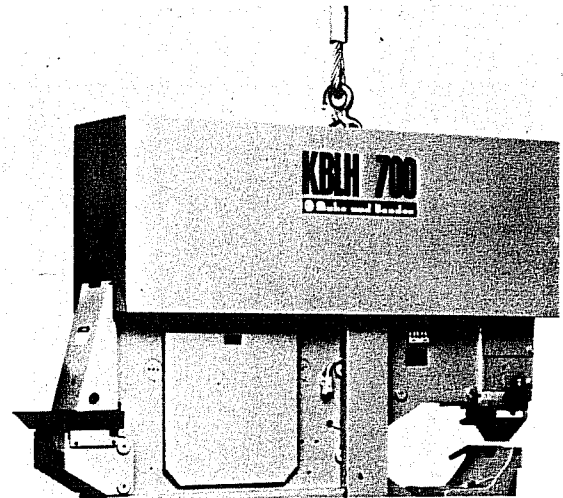

Fig. 2: Transport by crane

INSTALLATION

The working stations of the machine have normal working height. Height adjustment by means of platforms or foundations is superfluous.

All instructions required to provide a foundation at ground level for stationary installation can be learned from the foundation plan enclosed. Firmly tighten the foundation screws as soon as the filling compound has set. Instead of foundation screws, plugs can be used as well.

Check whether the machine has been positioned vertically.

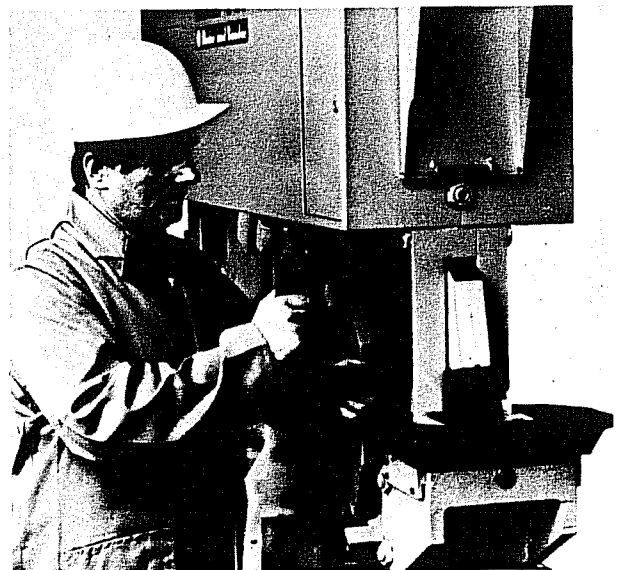

Fig. 3: Position check

CONNECTION AND STARTING

The drive and the appertaining oil reservoir are located in the machine base. See that the reservoir has been filled up to approx. 3 cm below its cover. Check by way of the charging inlet.

On refilling oil, mind the maintenance instructions.

The machine has been installed ready for operation. The switch cabinet with the main switch, to which the cables must be connected, is located in the machine base. Connection must be done by an electric expert according to the wiring diagramme. (Make sure that the voltages are identical).

Start motor briefly: in case motor will not run according to arrow direction, change two phases. For check of correct direction of rotation, briefly start motor only in tip mode.

Prior to starting, check whether the working slides move properly and the tools have been precisely adjusted. To do so, turn the selector switch to "INCHING", and move the slides stepwise to their lower dead positions. (Cf. section "Engagement").

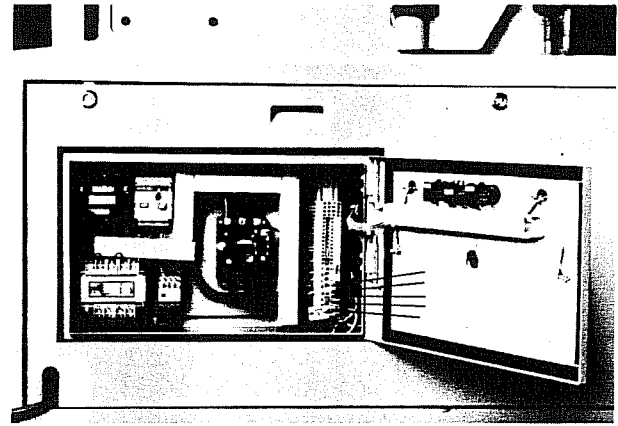

Fig. 4: Connection of power supply

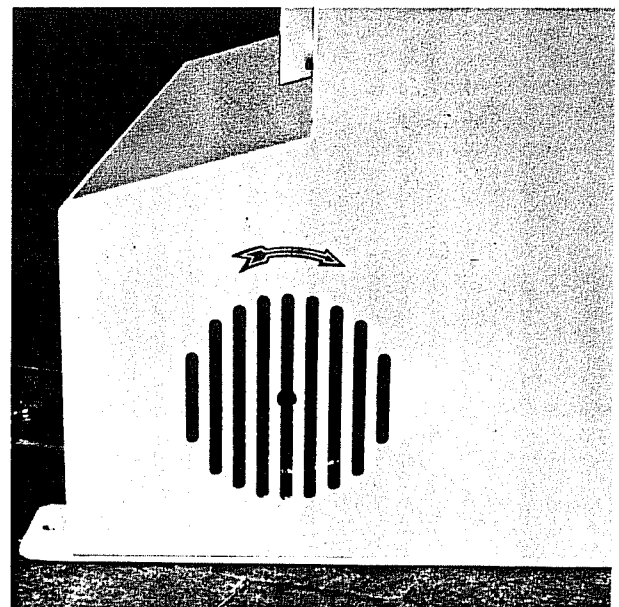

Fig. 5: Mind direction of motor rotation



LUBRICATING THE MACHINE

Types of Lubricants

In principle, grease the machine with oil only, whereby the same type of oil can be used at all lubrication points.

The following brands of oil can be used:

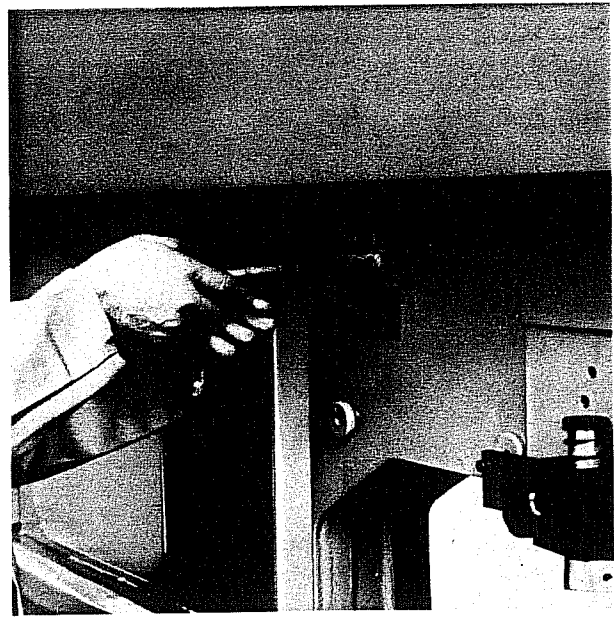

Fig. 6: Lubrication

ARAL Deganit B 220

Viscosity 130 mm²/s at 50⁰ C

SHELL Tonna oil T 220

Viscosity 128 mm²/s at 50⁰ C

MOBIL OIL AG VACTRA OIL No. 4

Viscosity 125 mm²/s at 50⁰ C

ESSO AG MILLCOTT K 220

Viscosity 120 mm²/s at 50⁰ C

BP ENERGOL HP - C 220

Viscosity 127 mm²/s at 50⁰ C

Grease the machine thoroughly.

(Cf. the lubrication chart.)

Lubricate by means of the delivered grease gun (tool kit).

Mind the enclosed lubrication chart, and take care that the prescribed quantity of oil is injected regularly.

Engagement

Every working station can separately be engaged, stopped, or returned from any position.

1. "Setting" and "Operation" Switch

The selector switches for tool setting and engagement are located under the coverings, within the safety hood. When the switch is set to "INCHING", the working slide can stepwise be moved to its working position.

In this position, tools can be set, mounted, or dismounted.

When the selector switch is turned to "OPERATION", the corresponding working slide will automatically move to its upper start position.

2. Functions of the Foot Switches

When the switch has been set to "OPERATION", three functions can be actuated by means of the foot switches:

- a) Actuating the foot switch over the action point: - the slide will execute a down stroke.
- b) Disengaging the foot switch just below its action point: - the slid is stopped.
- c) Releasing the foot switch completely: - The slide will move to its upper dead position.

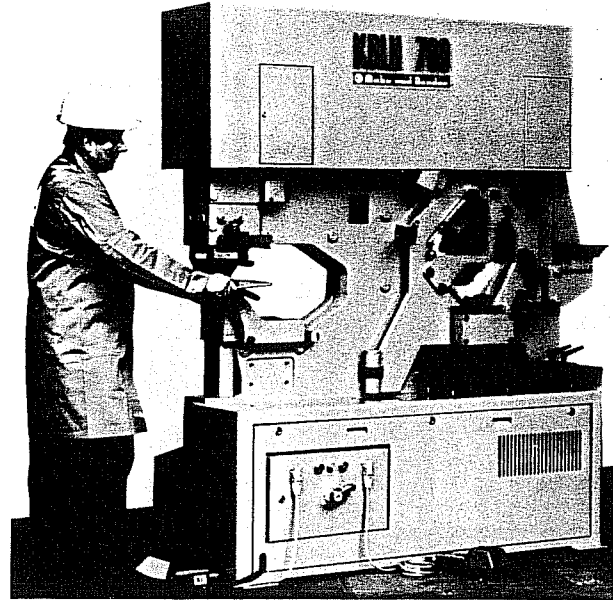

Fig. 7: Foot engagement punch

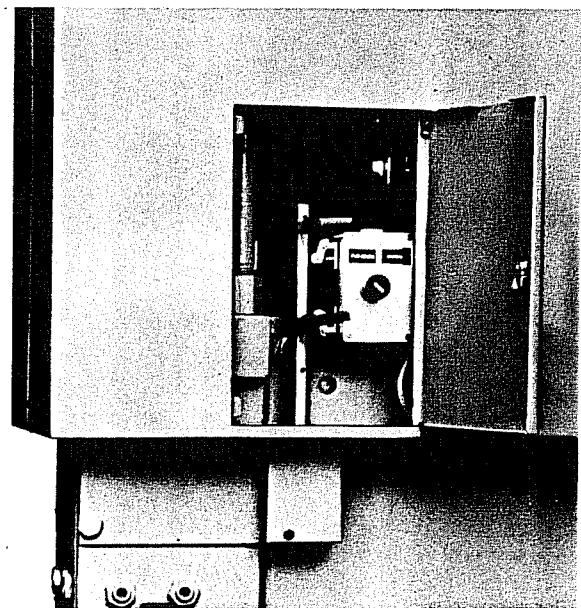

Fig. 8: Setting and operation switch, stroke adjustment punch

3. Stroke Adjustment

The control elements for adjusting position and length of stroke are located behind the casing flaps. Certain working operations do not require a full working stroke.

To save time, merely the working stroke required should be executed.

Adjust the position or length of stroke by means of the variable control rings installed on the control rods: the lower control ring sets the upper, the upper ring the lower stroke limit.

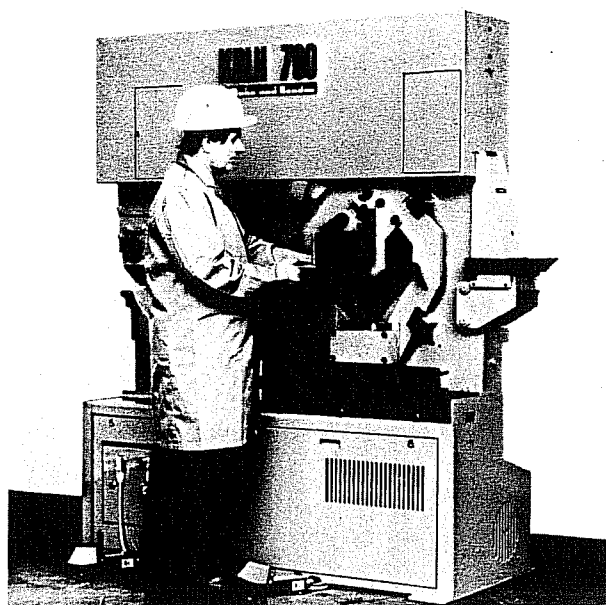

Fig. 9: Foot engagement shear

4. Connection of a Length Stop with Contact Switch

On the shear side, there is an additional plug for connecting a contact length stop.

As soon as the fed material activates the contact switch, the automatic shearing stroke is started, which means an important help for the operator, and increases the efficiency of the machine.

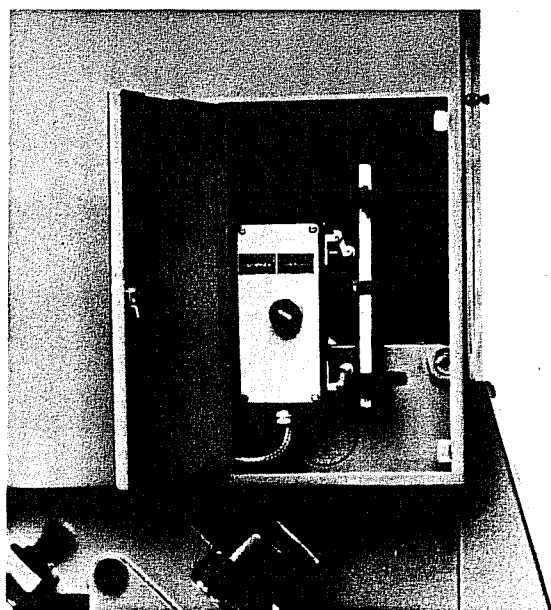

Fig. 10: Setting and operation switch, stroke adjustment shear

FLAT BAR SHEAR

1. Blades

The upper and lower blades are interchangeable, and can be used on four edges.

2. Regrinding the Blades

Regrind the blades in time (on their longer front sides only). Regrind rectangularly, and make sure that the front sides are plane to ensure proper adaptation to the slide and body. On doing so, always take care that grinding is done evenly so that the setting angle will not be changed. Replace worn-out blades by new MUBEA ones.

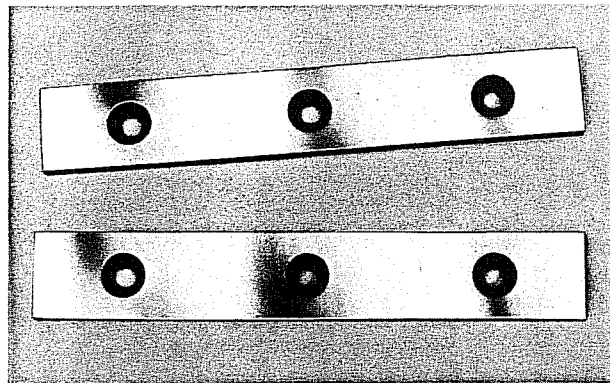

Fig. 11: Flat steel blades with 4 cutting edges

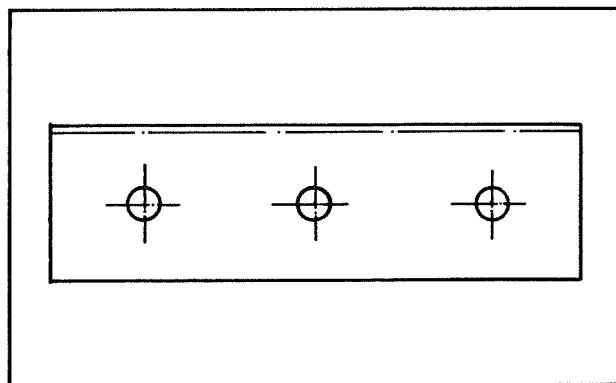

Fig. 12: Regrinding flat steel blades

3. Cutting Clearance

Set the cutting clearance of the blades to 0.2 or 0.3 mm, and check width of the clearance by means of a feeler gauge with the blade slide lowered.

In the factory, the blades have been adjusted such as to cut material of any thickness within the machine's capacity range. For cutting very thin material, reduce the clearance by adding paper board or metal shims.

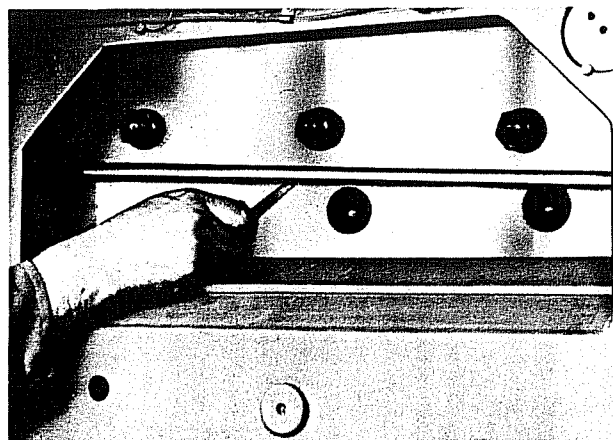

Fig. 13: Checking the cutting-clearance

4. Adjusting the Hold-down

The material to be cut must safely be locked in horizontal position. Improper adjustment of the hold-down causes notching or separation of the blades. On KBLH 300, the material must safely be clamped by the spindle hold-down before it is cut.

The automatic hold-down on KBLH 500 and 700 is set properly, if the hold-down bar lies evenly and close to the material to be processed, after the clamping stroke.

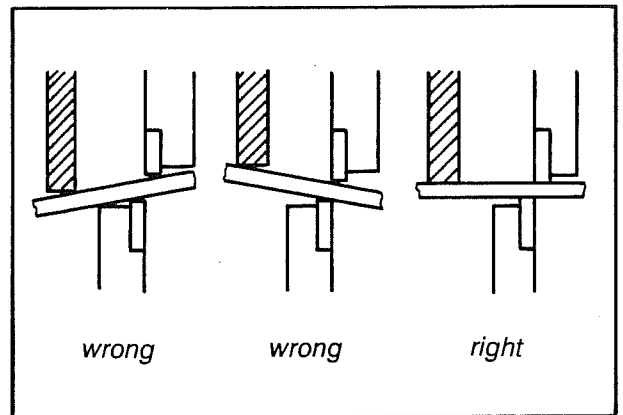

Fig. 14: Right and wrong adjustment of hold-down

5. Exchanging Blades

a) KBLH 300

Disassemble the supporting and guiding table. Loosen fastening screw "A", and take the lower blade from the machine, from the discharge side. Loosen fastening screws "B", and remove the upper blade (Fig. 16, 17).

Assemble in reverse order.

b) KBLH 500 and 700

Loosen clamping lever "A" actuating the supporting brackets "B", push the brackets outwards, and tighten. Swivel hold-down plate "C" to the front (Fig. 38).

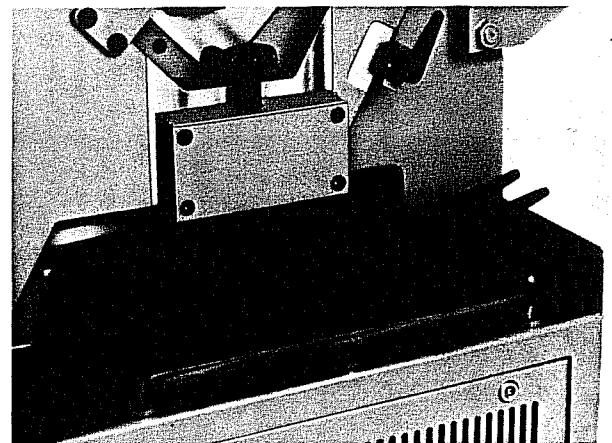

Fig. 15: Cutting flats

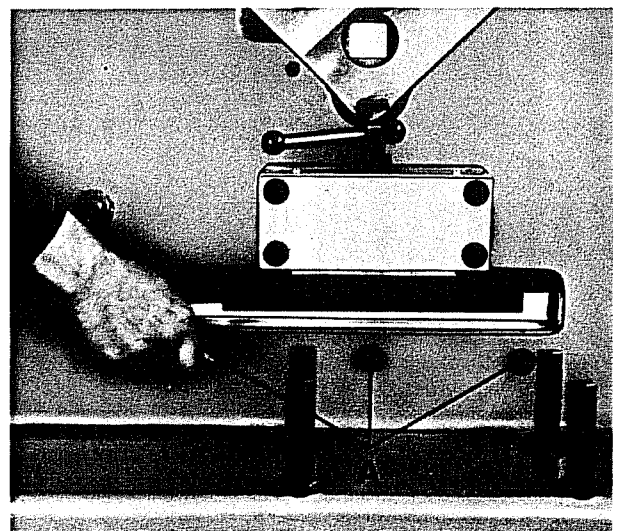

Fig. 16: Changing the lower flat steel blade (KBLH 300)

Loosen locking nuts "A", fastening nuts "B", and take the lower blade out of the machine, from discharge side.

Inch the working slide to its lower dead position.

Loosen locking nuts "C", fastening nuts "D", and eject blade screws "E" to the front, through the opening of the blade. When doing so, see that the upper blade will not fall down. (Cf. fig. 18, 19).

Assemble in reverse order.

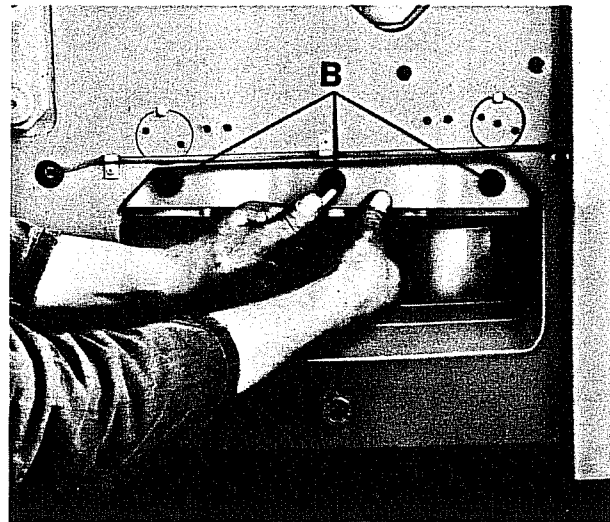

Fig. 17: Changing the upper flat steel blade (KBLH 300)

6. Re-adjusting the Slide Guides

The guides of special sliding material, on which the long slide runs, can be adjusted universally. Thus clearance-free guide even after long service is ensured.

Re-adjust as follows:

- a) Frontal (see fig. 20):
First, loosen the locking nuts "A" by lefthand rotation. Tighten pressure screws "B" up to resistance, by means of a screw driver. Then loosen pressure screw "B" again by about 1/16 rotation, and tighten locking nut "A". This must be done to ensure proper guide of the slide.

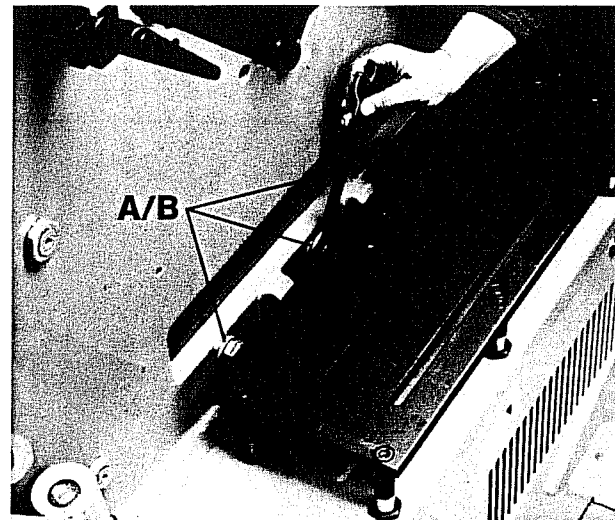

Fig. 18: Changing the lower flat steel blade (KBLH 500/700)

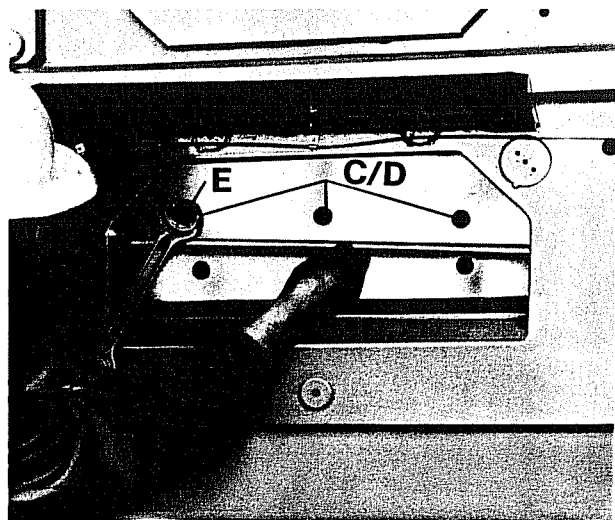

Fig. 19: Changing the upper flat steel blade (KBLH 500/700)

b) Lateral (Cf. fig. 21):
Prior to re-adjustment,
disassemble the section and the
flat steel blades, as well as the
coping/notching tools.

To re-adjust, loosen locking
screws "A", and adjust the guide
screws "B". First, tighten the
guide screws "B", and then loosen
them again by about 1/16 rotation.
This ensures proper seat of the
slide. All 6 guide screws (8
screws on model KBLH 700) must be
adjusted in this way.

With the adjustment having been
finished, drill guide screws "B"
by means of a 4.5 mm drill, and
fasten by locking screws "A".

Now, first install the flat
steel blade, lower the blade
slide, and check width of the
cutting clearance. (See section
"Flat steel shear").

In case the cutting clearance
should be too small or wide,
regrind, or insert shims.

After the flat steel blades have
been installed and checked,
mount the section blades and the
coper/notcher, and carefully
check width of the cutting
clearance.

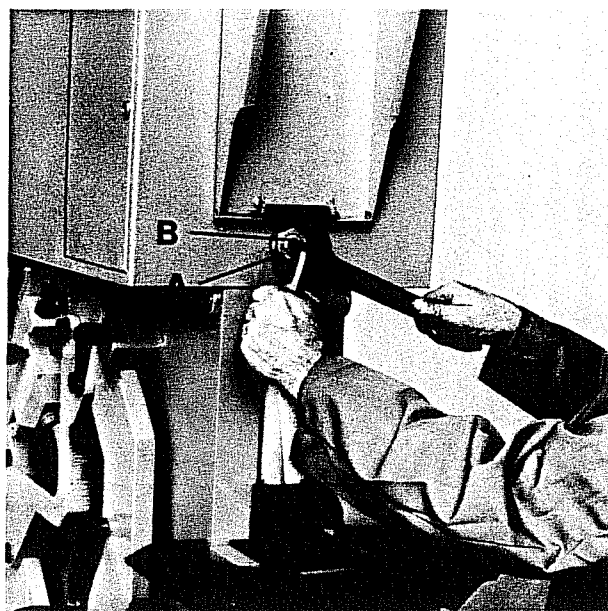

Fig. 20: Adjusting the slide
guide - on the front

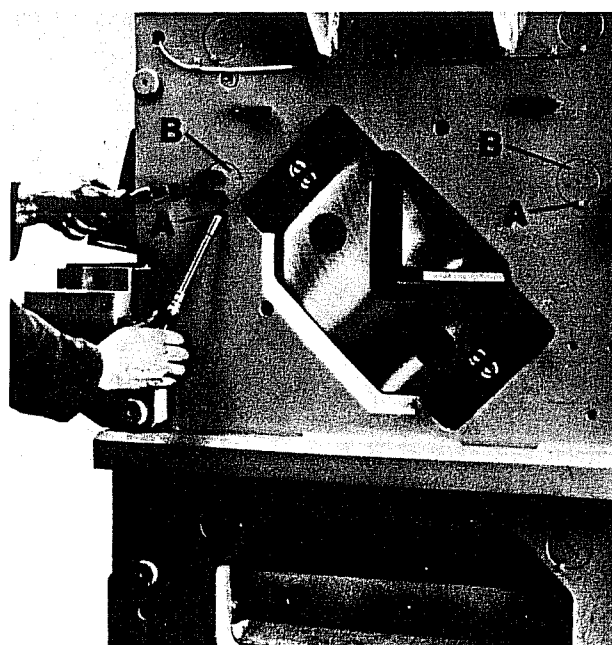

Fig. 21: Adjusting the slide
guide - laterally

COPER/NOTCHER

1. General

On request you have got a machine equipped either with the triangular notching or the rectangular coping tool. These tools can easily be interchanged and ordered subsequently.

2. Triangular Notcher

This tool is especially suitable for economic production of frames out of angles or tees. To prevent any upsetting in the area of the section root, the tip of the triangular notcher is flattened. Thus the section can be bent to frames.

By inserting the angles to be processed under 45° , the triangular notcher enables performance of rectangular and notchings. By means of appropriate feed, any length desired can be obtained.

To notch the web of tees, remove the front cross blade "A" by loosening screw "B", so that the flange of the tee can be inserted.

3. Rectangular Coper

The rectangular coper is most suitable to cope flanges and webs. Wider or deeper copings can be obtained by appropriate feed. To notch triangularly, insert the material under 45° . However,

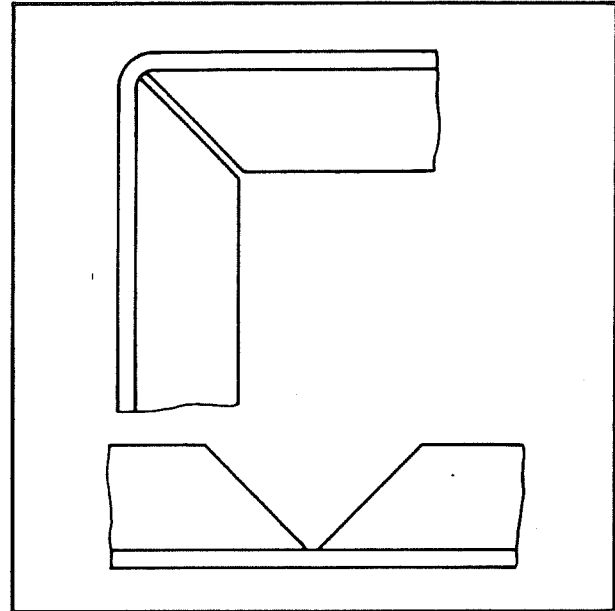

Fig. 22: Triangular notching for frame bending

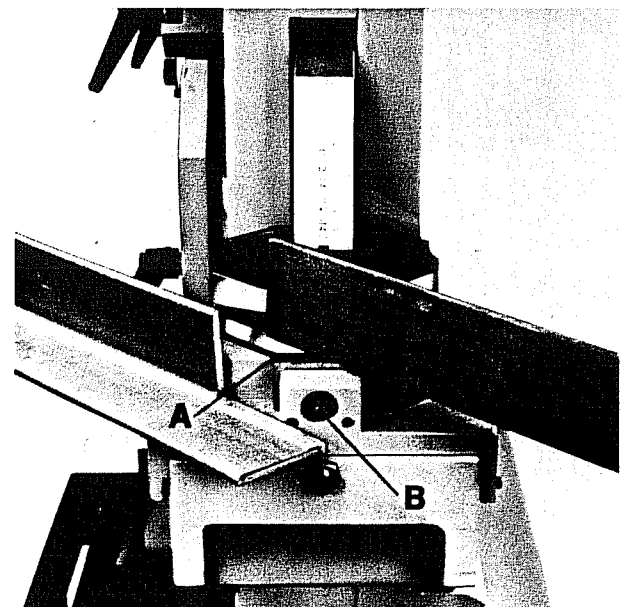

Fig. 23: Rectangular copings by means of triangular notcher

because of the then resulting sharp edges, this procedure is not to be recommended for manufacturing frames.

4. Adjusting the Coping/Notching Tools

As the coping saddle is universally adjustable, the tool's underpart can easily be adjusted to the upper blade.

Mind evenness of the cutting clearance.

The cutting clearance has already been adjusted for maximum performance. Reduce the clearance when coping very thin material. To do so, lower the blade slide until the upper coping blade just inserts into the underpart of the tool, and check width of the cutting clearance by means of a feeler gauge.

To adjust the tool (Cf. fig. 27), loosen the saddle screws "A", locking nut "B", and pressure screw "C", and properly adjust the saddle by means of the setting screws "D". Tighten saddle screws "A", pressure screw "C", and lock by nut "B".

5. Grinding the Rectangular and Triangular Coper-Notcher

Grind the upper blades on their lower, the lower blades on their upper faces only. When installing the blades, take care of the proper cutting clearance. (Daub the cutting edges with oil several times.)

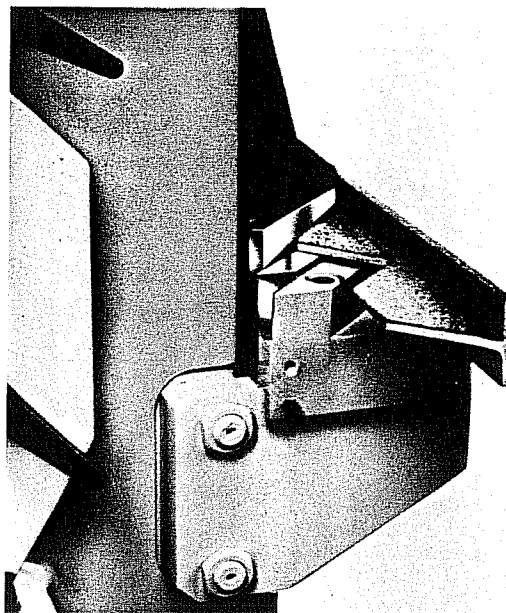

Fig. 24: Notching the webs of tees

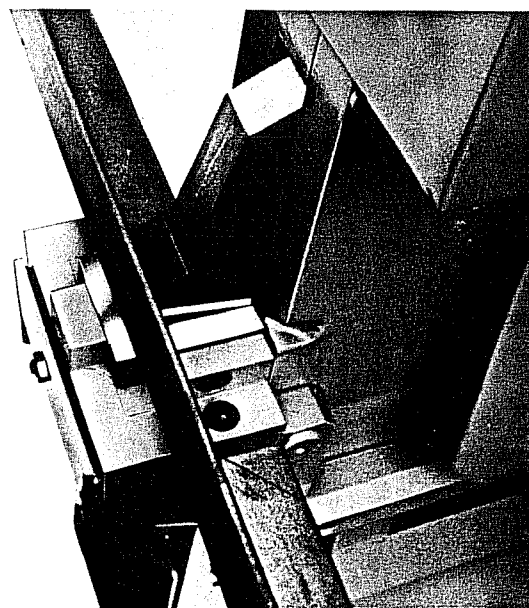

Fig. 25: Wide rectangular coping

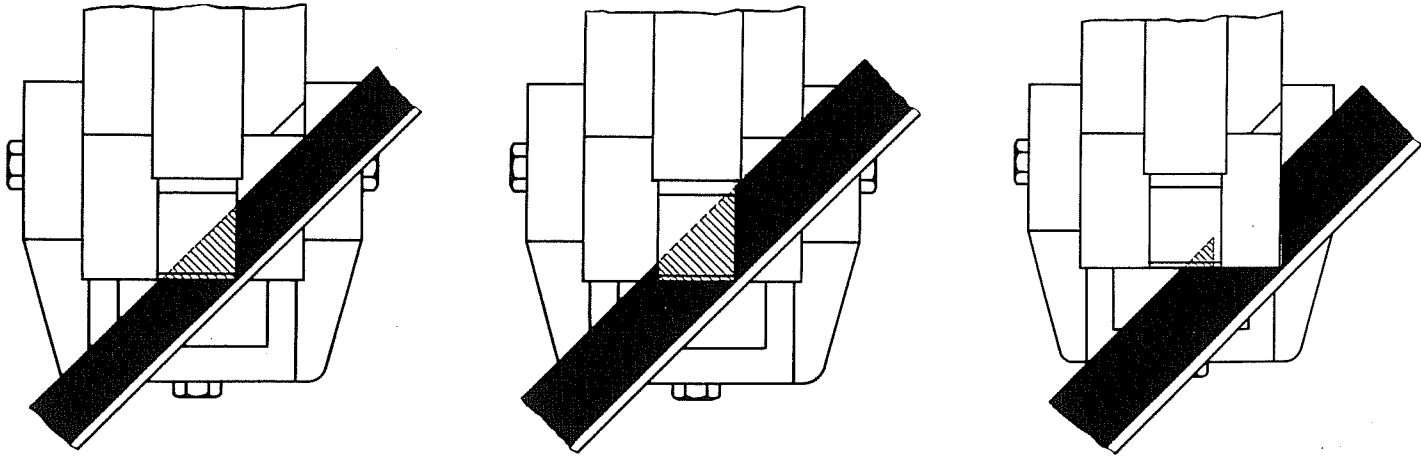

Fig. 26: Provisional triangular notching by means of rectangular coper

6. Special Tools

Instead of standard triangular and rectangular coping/notching tools, other special coping/notching tools can be used as well, such as coping tools for rounding fish plates or tools for coping flats to be welded to round bars or tubes.

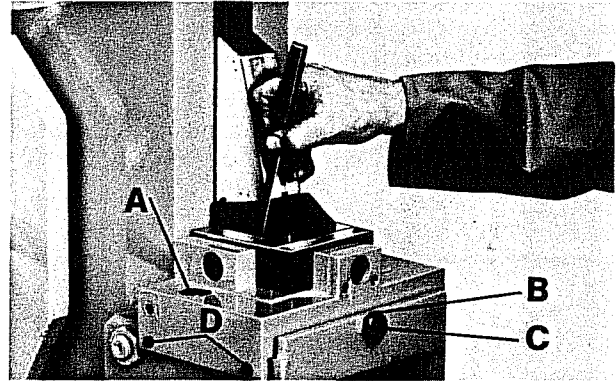

Fig. 27: Checking the cutting clearance

7. Special Accessories

For notching without previous scribing, we additionally supply special supporting tables, index rails etc.

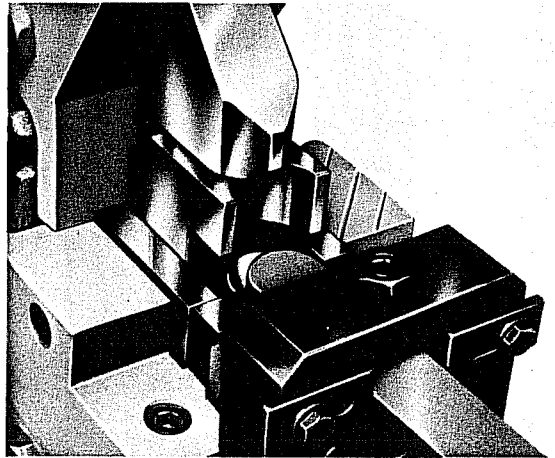

Fig. 28: Rounding flats

Please let us know your inquiries. So we can prepare, and offer the best possible solution.

Please note!

The coper/notcher has been provided with a safety hood.

We strongly advise you to keep this safety device always ready for use.

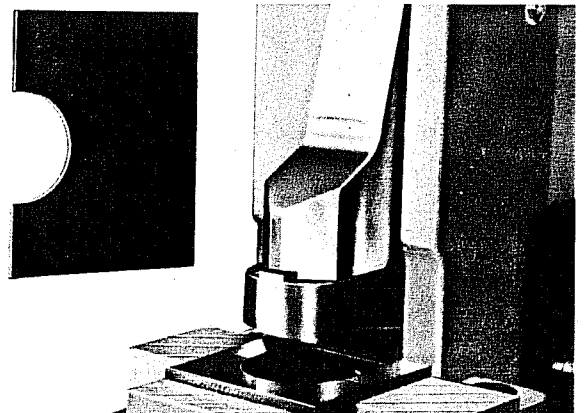

Fig. 29: Rounding out flats

SECTION SHEAR

1. General

The movable section blade is moved by the vertically running shear slide. The running direction of the movable section blade is turned round to 45° by means of the guides firmly installed within the machine body. This construction enables mitre cuts as well as feeding angles and other steel sections by means of flat tracks.

2. Adjusting the Slide Guides

The guide of special sliding material, on which the long slide runs, can be adjusted universally. Thus clearance-free guide even after long service is ensured, which means an important safety measure regarding the immense forces occurring at the section shear.

Re-adjust the slide as described under "Flat steel shear" item 6.

3. Removing Scales

There are channels between the body plates and the shear slide. Due to width of these channels, dry scales will fall perfectly through. However should scales accumulate, rinse the channels by petroleum.

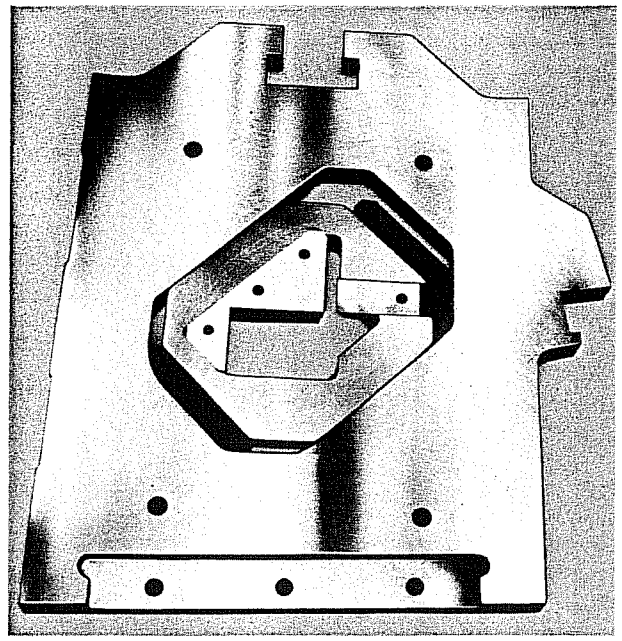

Fig. 30: Drive of the movable section blade within the section slide

4. Types of Blades

A) PMG Blades

In standard version, the machines are equipped with blades for cutting angles (90° and 45°) and tees (90°). A detailed description as well as maintenance and operation instructions for your blades are given below.

1. Dismounting the Section Blades

(KBLH 300: cf. fig. 31, 32, 37, KBLH 500 and 700: cf. fig. 33, 34, 38)

a) KBLH 300: Loosen clamping lever "B", and push the hold-down plate "C" off the stop rail (Cf. fig. 37).

b) KBLH 500/700: Loosen clamping lever "A", push supporting bracket "B" outwards, and tighten again. Remove hold-down plate "C" to the front (Cf. fig. 38).

c) Unscrew the four cylinder screws "D".

d) Remove stationary section blade "E" from the machine.

e) Remove movable section blade "F" from the machine.

f) When cleaning the blades, carefully inspect the stationary and movable guides within the machine body, in the slide and the blade itself.

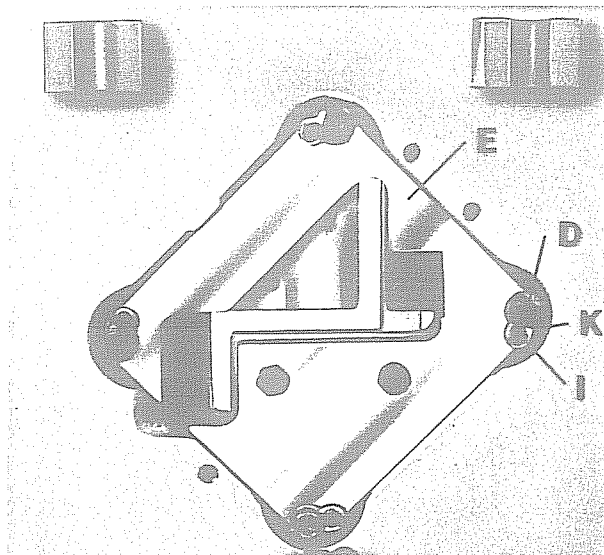

Fig. 31: PMG section blade, seen from body side (KBLH 300)

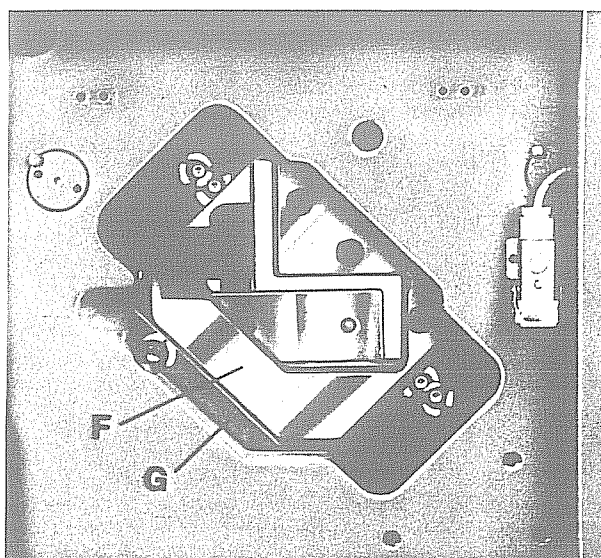

Fig. 32: PMG section blade, seen from cover plate side (KBLH 300)

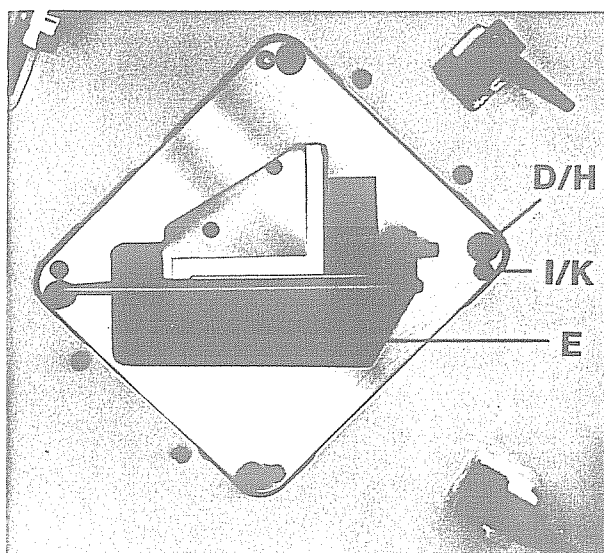

Fig. 33: PMG section blade, seen from body side (KBLH 500/700)

2. Installing the Section Blade

(KBLH 300: Cf.fig. 31, 32, 37
KBLH 500/700: Cf.fig. 33, 34, 38)

- a) Prior to mounting the movable section blade "F", properly lubricate the outer guide sides (Cf. fig. 36, arrows).
- b) Insert the movable section blade "F" into section slide "G", and press it on the guides backwards till it sits close to the stop.
- c) Insert the stationary section blade "E" into the body.
- d) Insert cylinder head screws "D" together with disk spring "H", and tighten.
- e) Tighten setscrew "I".
- f) Loosen cylinder head screw "D" by a full rotation, and tighten the four setscrews "I" by approx. 1/8 rotation to the right. This must be done to prevent the two blades from being drawn one on top of the other, and to ensure a proper cutting clearance.
- g) Tighten cylinder head screws "D" by means of a wrench extension (approx. 300 mm), and lock setscrew "I" by means of locking cap "K". (On KBLH 300, lock cylinder head screw "D" by means of washer "K")
- h) KBLH 300: Push hold-down plate "A" onto the stop rail, and lock by means of the clamping levers.

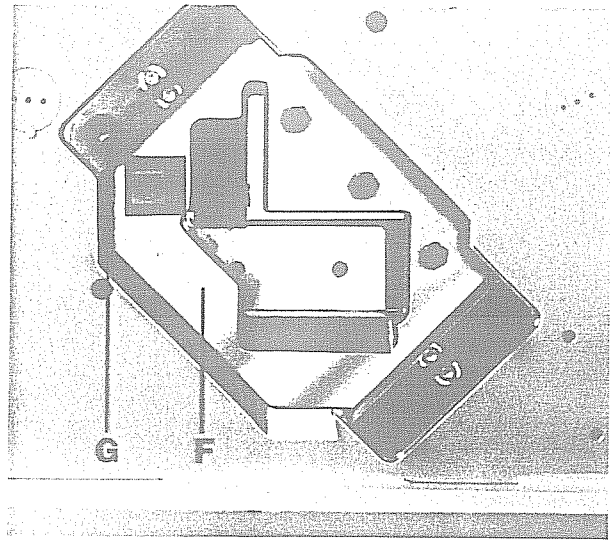

Fig. 34: PMG section blade, seen from cover plate side (KBLH 500/700)

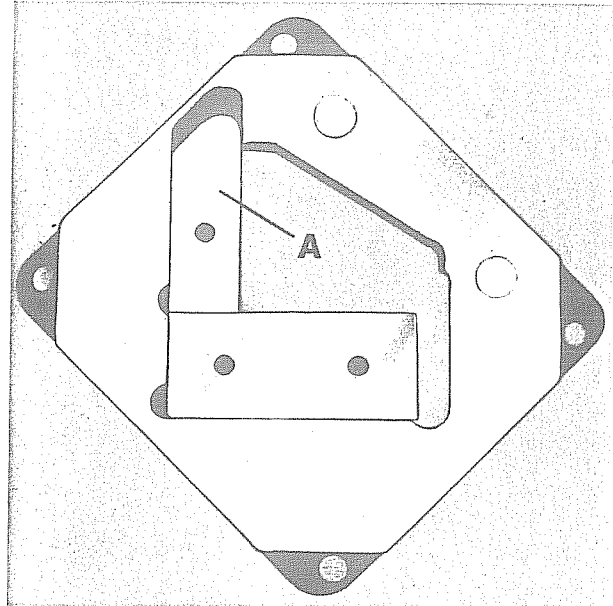

Fig. 35: PMG section blade, stationary

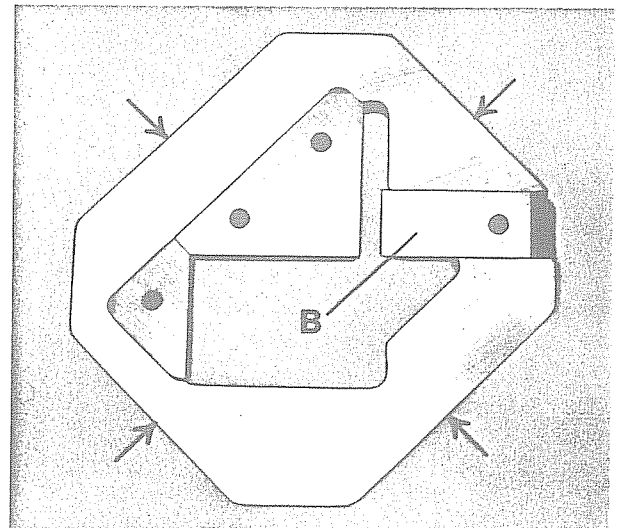

Fig. 36: PMG section blade, movable

i) KBLH 500/700: Swivel in hold-down plate, and lock by means of supporting brackets "B".

3. Cleaning the Section Blades

The section blades need no extensive maintenance, for there are no trouble-prone parts. You merely should clean them in time, depending on the resulting amount of scales.

a) Disassembling the section blades according to instructions given under item 1.

b) For disassembling the sliding blades "A" and "B" (see fig. 35 and 36).

c) Thoroughly clean both the section and the insert blades.

d) Assemble in reverse order.

e) Install the section blades acc. to the instruction, item 2.

To be noted:

To keep the scales dry, the section blades must be free from grease.

4. Regrinding the Section Blades

Regrind the sliding and insert blades evenly, and on their front cutting faces only. In case of improper regrinding, i.e., if the edges will not meet at one point, there will be no clear cut.

Regrind the sliding and insert blades only so that, after the slide has been moved to its

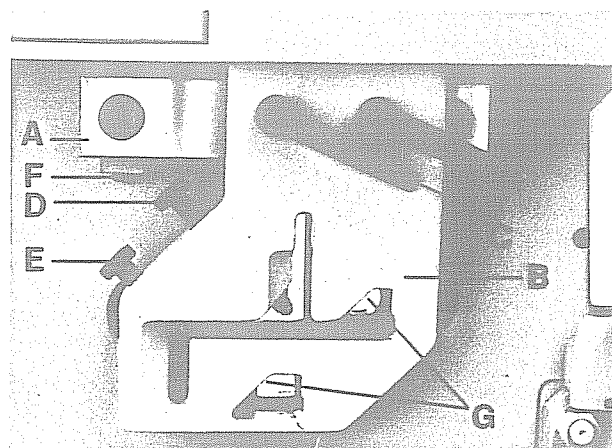

Fig. 37: Hold-down KBLH 300

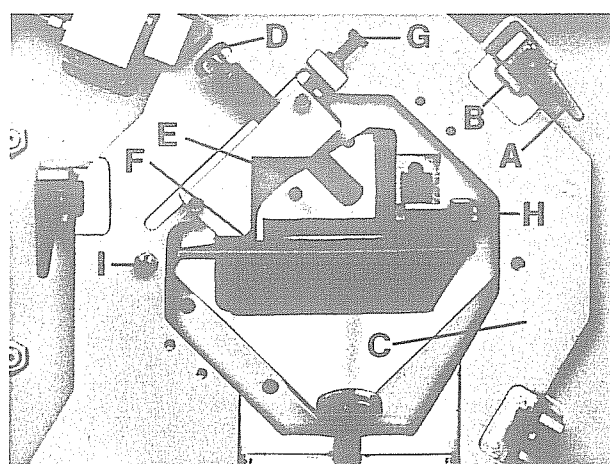

Fig. 38: Hold-down KBLH 500/700: design for PMG blades

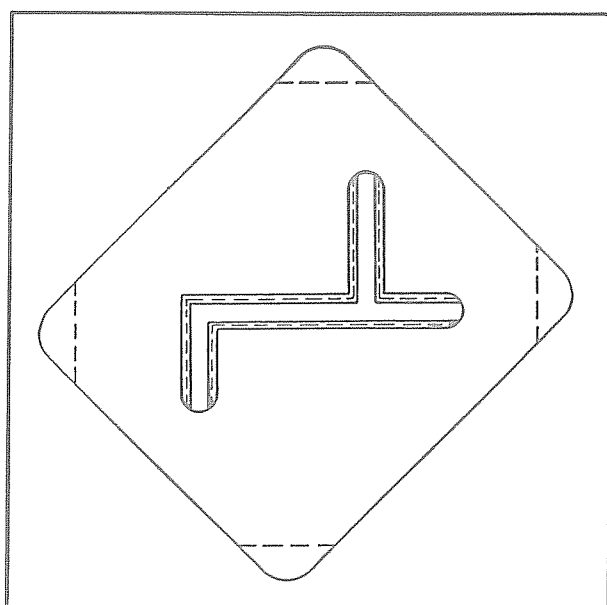

Fig. 39: Regrind blades evenly

lowest position, the blade will completely and evenly cover the cutting edges. Otherwise, the blades must be replaced. (The corresponding article number, which is your order number, is shown on the blades). Please order Original MUBEA blades only.

To enable cutting all kinds of steel sections (even sharp-edged ones), the sliding and insert blades are pointed. For processing steel sections with different root radii, the blades can be provided with adequate radii. Thus there will be no deformation in the root area.

5. KBLH 300 Hold-down

(Cf. fig. 37)

According to marks engraved on the stop rail "A" ($90^{\circ}/45^{\circ}$), the hold-down can be properly adjusted. It is fixed by means of the clamping levers "C".

Adjust the proper height of the steel section by means of the hold-down screws "D" (for 90° cuts), respectively "D" and "E" (for 45° cuts).

When the material lies evenly and horizontally during being cut, height is correct. In case of resulting incorrect vertical leg re-adjust stop rail "A" by means of the setting screws "F" (required in case of processing sections of different size).

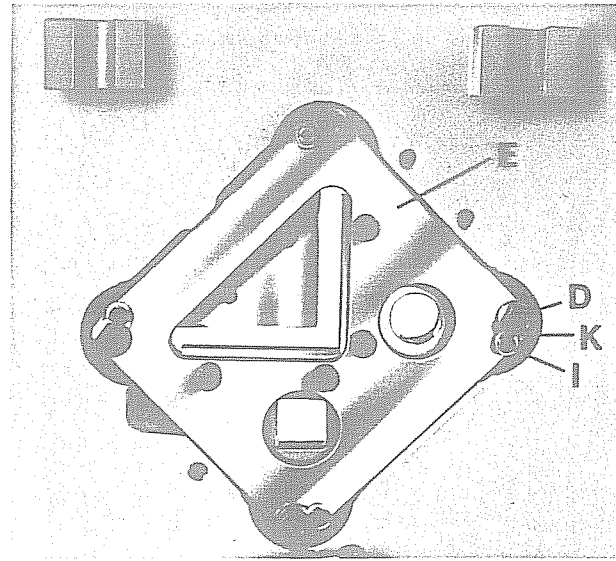

Fig. 40: Blades for angles, seen from body side (KBLH 300)

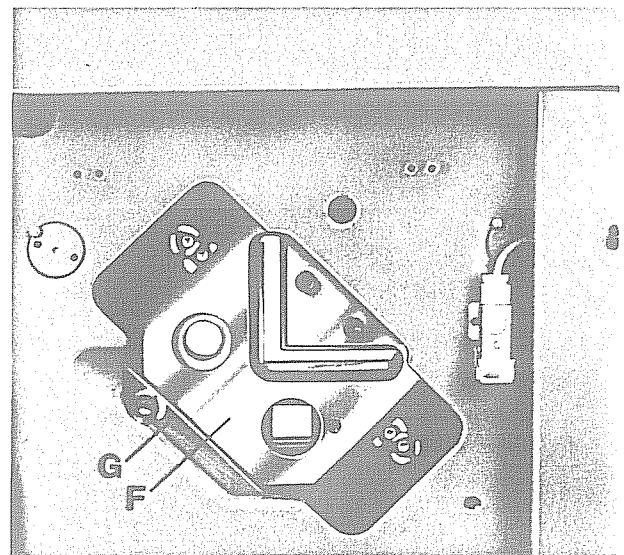

Fig. 41: Blade for angles, seen from cover plate side (KBLH 300)

In case of incorrect horizontal leg, correct by shifting the hold-down on the stop rail.

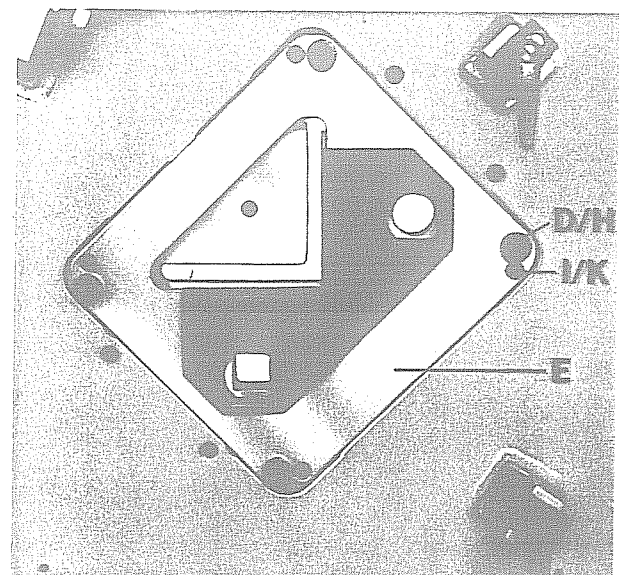

Fig. 42: Blade for angles, seen from body side (KBLH 500/700)

6. Hold-down - KBLH 500/700
(. . fig. 38)

The automatic hold-down has been designed in such shape, that for rectangular cuts the material is fixed by pressure screw "D", for mitre cuts, by the stop edges "E" and "F" of the pressure piece. For 90° cuts, adjust by means of the pressure screw, for mitre cuts by shifting the pressure piece laterally. Should the latter one have been shifted, adjust the stop screw "G", and lock. In case of using special blades, pull the pressure piece down through the channels of the hold-down plate. Then another pressure piece can be used.

While cutting, take care that the tip of the pressure screw exactly meets the root of the steel section to be processed, respectively, that when doing mitre cuts, the stop edges of the pressure piece sit close to the material.

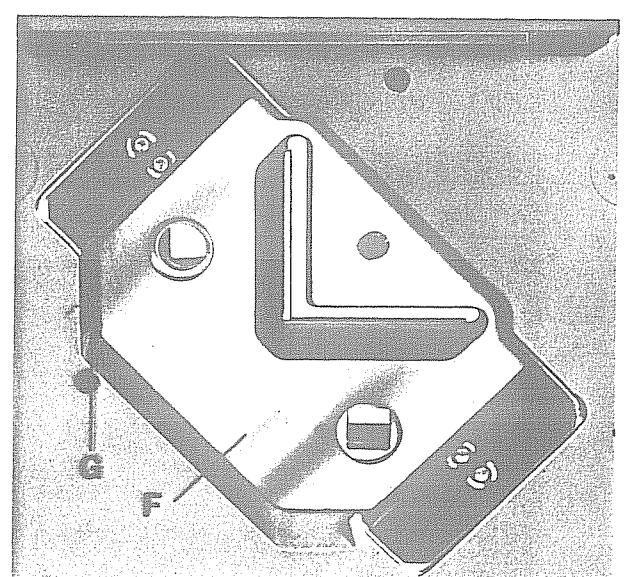

Fig. 43: Blade for angles, seen from cover plate side (KBLH 500/700)

In case the cut will not be done at exactly right angle or 45° , adjust by means of the screws "H" (for 90°) and "I" resp., or slightly shift the pressure piece (for 45° cuts). Cf. fig. 38.

B) PML Section Blades

The machines can be equipped with blades for cutting angles at 90° , as well as blades for cutting round and square bars. This type of blade can be installed very easily. For detailed description, as well as maintenance and operation hints for your blades, please study the following instructions.

1. Dismounting the Section Blades

(KBLH 300: Cf. fig. 40, 41, 46, KBLH 500 and 700: Cf. fig. 42, 43, 47)

- a) KBLH 300: Loosen clamping levers "B", and push the hold-down plate "C" off the stop rail (Cf. fig. 46).
- b) KBLH 500 and 700: Loosen clamping lever "A", push supporting brackets "B" outwards, and tighten. Swivel hold-down plate "C" to the front (Cf. fig. 47).
- c) Unscrew the 4 cylinder head screws "D".

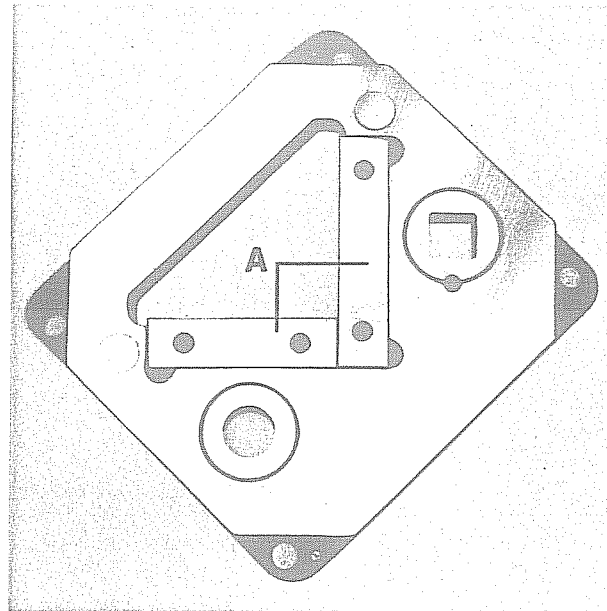

Fig. 44: Blade for angles, stationary

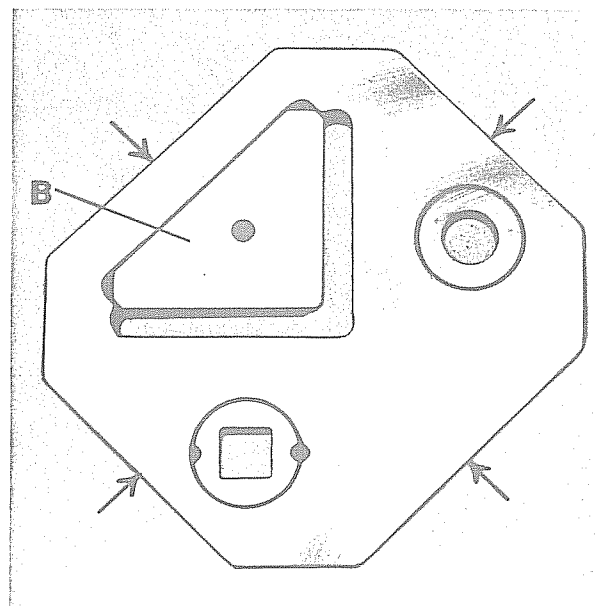

Fig. 45: Blade for angles, movable

- d) Take the stationary section blade "E" out of the machine.
- e) Take the movable section blade "F" out of the machine.
- f) On cleaning the blades, carefully inspect the stationary and the movable guides in the machine body, the slide and the blade itself.

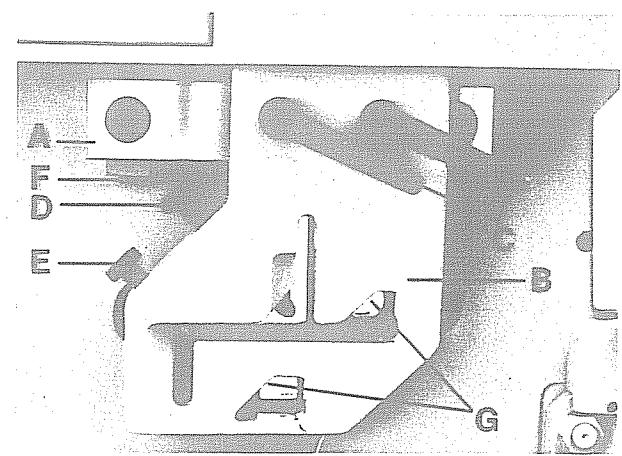

Fig. 46: Hold-down KBLH 300

2. Installing the Section Blades

(KBLH 300 - Cf.fig. 40, 41, 46, KBLH 500 and 700 - Cf.fig. 42, 43, 47)

- a) Prior to mounting the movable section blade "F", properly lubricate the outer guide sides (See fig. 45, arrows).
- b) Insert the movable section blade "F" into section slide "G", and press it on the guides backwards till it sits close to the stop.
- c) Insert the stationary section blade "E" into the body.

d) Insert the cylinder head screws "D" together with the disk springs "H", and tighten.

e) Tighten setscrew "I".

f) Loosen cylinder head screws "D" again by a full rotation, and tighten all 4 setscrews "I" by approx. 1/8 rotation to the right. This must be done to prevent the two blades from being drawn one on top of the other, and to ensure a proper cutting clearance.

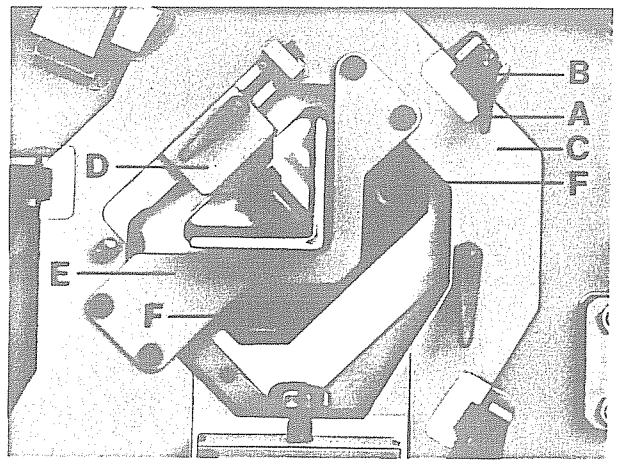

Fig. 47: Hold-down KBLH 500/700, design for blades for angles

g) Tighten the cylinder head screws "D" by means of a wrench extension (approx. 300 mm), and lock setscrew "I" by locking cap "K". (On KBLH 300, lock cylinder head screw "D" by means of washer "K".)

h) KBLH 300: Push hold-down plate "A" onto the stop rail, and lock by means of the clamping levers.

i) KBLH 500/700: Swivel in hold-down plate, and lock by means of supporting brackets "B".

3. Cleaning the Section Blades

The section blades need no extensive maintenance, for they have no trouble-prone parts. Clean them in time, depending on the resulting amount of scales.

a) For disassembling the section blades, confer instruction, item 1.

b) Disassemble the insert blades "A" and "B". (See fig. 44 and 45).

c) Thoroughly clean both the section and the insert blades.

d) Assemble in reverse order.

e) For installation of the section confer instruction, item 2.

To be noted: To keep the scales dry, the section blades must be free from grease.

4. Regrinding the Section Blades

Regrind the insert blades evenly and only on their front cutting faces. In case of improper regrinding, i.e., if the edges will not meet at one point, there will be no clear cut.

Regrind the insert blades only so far that, after the slide has been moved to its lowest position, the blade will completely and evenly cover the cutting edges. Otherwise, the blades must be replaced. (The article number which is identical with your order number, is shown on the blades). Please order Original MUBEA blades only.

The insert blade withing the movable blade is pointed to enable cutting of all kinds of sections, even sharp-edged ones. For processing steel sections with given root radii, the blades can be provided with adequate radii. Thus there will be no deformation in the root area.

5. Hold-down KBLH 300

(Cf. fig. 46)

According to the mark on stop rail "A", hold-down "B" can be set for 90° cuts. It is fixed in the position wanted, by means of the clamping levers "C".

Adjust proper height of the section to be processed by means of hold-down screw "D".

Adjustment is correct, when the material lies evenly and horizontally during being cut.

In case of incorrect vertical leg, adjust stop rail "A" by means of the setting screws "F" (Required when processing sections of different size).

In case of incorrect horizontal leg, adjust by shifting the hold-down on the stop rail.

When cutting round and square sections, move the hold-down on the stop rail to a position ensuring safe horizontal clamping of material by the stop edge.

6. Hold-down KBLH 500/700

When using the combined blade for angles, round and square steel sections, push the appertaining pressure piece "D" onto the hold-down plate, and screw the hold-down rail "E" by the pressure screws "F" for round and square sections to the hold-down plate (See fig. 47).

When cutting angles, make sure that the tip of the pressure screw exactly meets the root of the steel section to be processed. Cutting round or square steel must be done in such manner that the material to be processed is safely clamped in horizontal position, by means of the pressure screw.

C) Special Blades

a) Quick-Change Blades

In case you will process channels, I-beams or other steel sections in frequently changing succession, you should use MUBEA Quick-Change Blades, consisting of a blade holder and insert blades.

Then you only need the considerably cheaper insert blades for each shape of steel section to be processed.

Changing blades is done in virtually no time, i.e. the clamping levers can be loosened, the insert blades removed, and new blades inserted by only a few movements and without any helping devices.

The uniform working height means a further important advantage of quick-change blades, when processing different steel sections.

This is very important in case there is a feed conveyor.

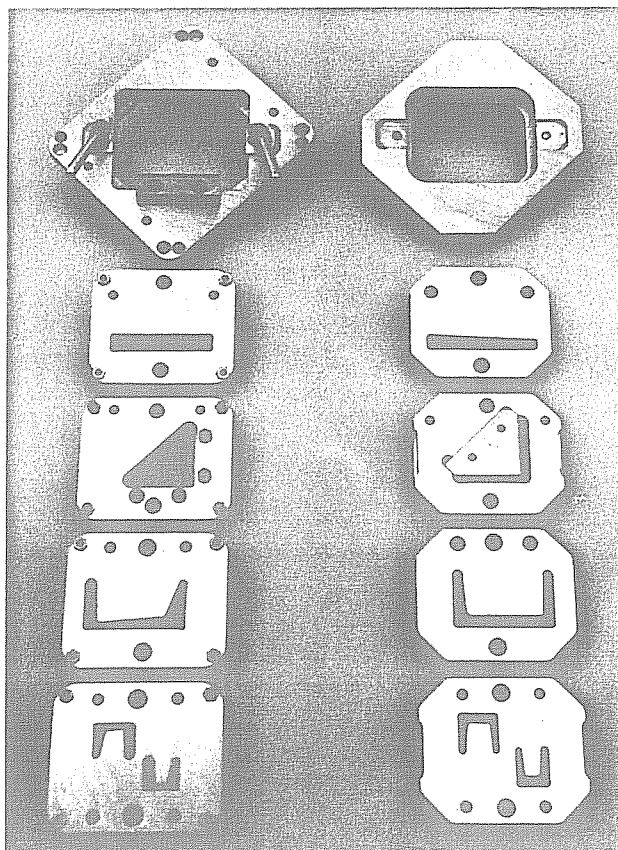

Fig. 48: Quick-change blade section shear

b) Section Blades for Special Steel Sections

For cutting channels, I-beams, zees or other special steel sections, we can supply section blades with stationary cutting inserts.

Depending on the section size, several cutting openings can be incorporated in one pair of blades.

Standardized section blades can be supplied for channels and I-beams of DIN standard.

For steel sections of identical dimensions, combined blades for channels and I-beams can be supplied.

c) Pipe Notcher

The low-priced pipe notching device for the section shear means a special advantage. By means of this equipment, pipes of up to 60 mm outer diameter and a maximum thickness of 6 mm can be processed. For processing pipes of different diameter, you only need the 2 cutting inserts for the moveable and the stationary blade.

PUNCH

USE ONLY PUNCHING DEVICES AND TOOLS WHICH ARE UP TO THE CUTTING AREA SUFFICIENTLY GUARDED AGAINST FINGER INJURY.

In case of using unprotected tools for insert operations, mind the safety rules reg. bending operations on powered press brakes, published in ZH 1/387, 4th edition, 1981.

1. General

Owing to its advantageous construction, the MUBEA punch is much more than a simple hole punching unit, for it can perform many tasks which previously required use of an eccentric press.

The clamping surface of the very long punch slide is of very large and nearly square cross section. Thus, large and projecting tools can be used without difficulty, for due to the length of the slide, tilting forces can easily be compensated.

Even most complicated punchings and copings can precisely be performed by using various special tools, such as multiple-punch, follow-on, and guided die tools etc., all manufactured by the MUBEA Tool Manufacturing Department.

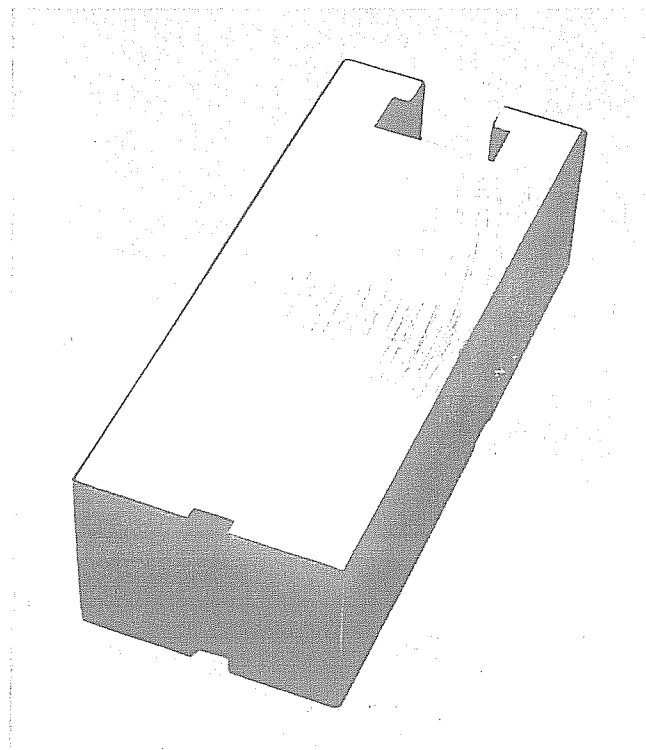

Fig. 54: Punch slide

2. Adjusting the Slide Guide

The guides of special sliding material, on which the long slide runs, are universally adjustable. Thus clearance-free guide even after long service is ensured.

Adjust as follows:
(See fig. 55, 56)

First, loosen locking nuts "A" by lefthand rotation. Tighten pressure screws "B" up to resistance, by means of a screw driver. Then lift pressure screw "B" by approx. 1/16 rotation, and tighten locking nut "A". This must be done to ensure proper guide of the slide.

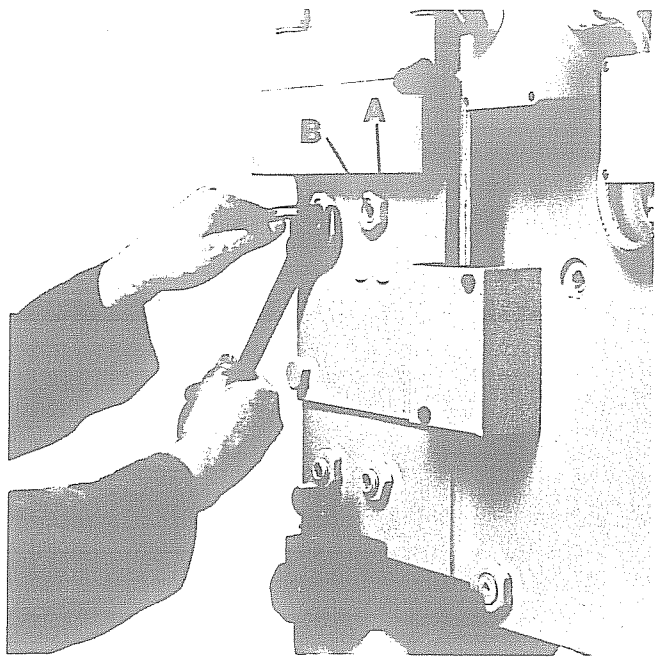

Fig. 55: Re-adjusting the slide guide laterally

3. Saddle and Saddle Support

The construction of MUBEA punches intentionally provides a special saddle support "B/C" to support punch saddle "A". Advantage of this design is that thus the saddle cannot spring or tilt, and the punching pressure is vertically led into the machine body.

The saddle support can remain mounted for all punching operations. Only when punching flanges of channels and I-beams, it must be removed. To do so, merely loosen mounting screw "D" (See fig. 57).

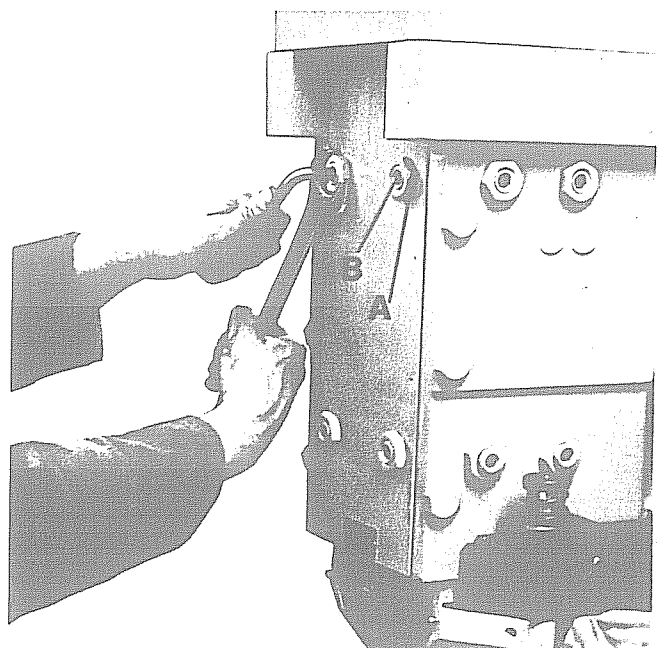

Fig. 56: Re-adjusting the slide guide on the front

This construction is especially advantageous when using big and projecting tools, for thus they can safely and universally be supported which means the best possible protection.

4. MUBEA Standard Punches and Dies

MUBEA punches and dies are available in 4 standardized sizes, and will fit all machines:

- Size I up to 15 mm dia.
- Size II over 15 mm up to 30mm dia.
- Size III over 30 mm up to 40mm dia.
- Size IV over 40 mm up to 50mm dia.

The standard machine equipment allows use of punches and dies up to size II.

For punches and dies exceeding this standard range, see section 10, "Special Tools".

For punching flanges of channels or I-beams, we supply flange punching dies with inclined surface matching the inclination of the steel section to be processed. To punch small angles, tees, channels or I-beams according to gauge line near the web, flange or leg, eccentric dies are required, having the bore near their edges. When mounting the eccentric dies, push the punch saddle backwards until the punch and the bore of the die lie on one axis.

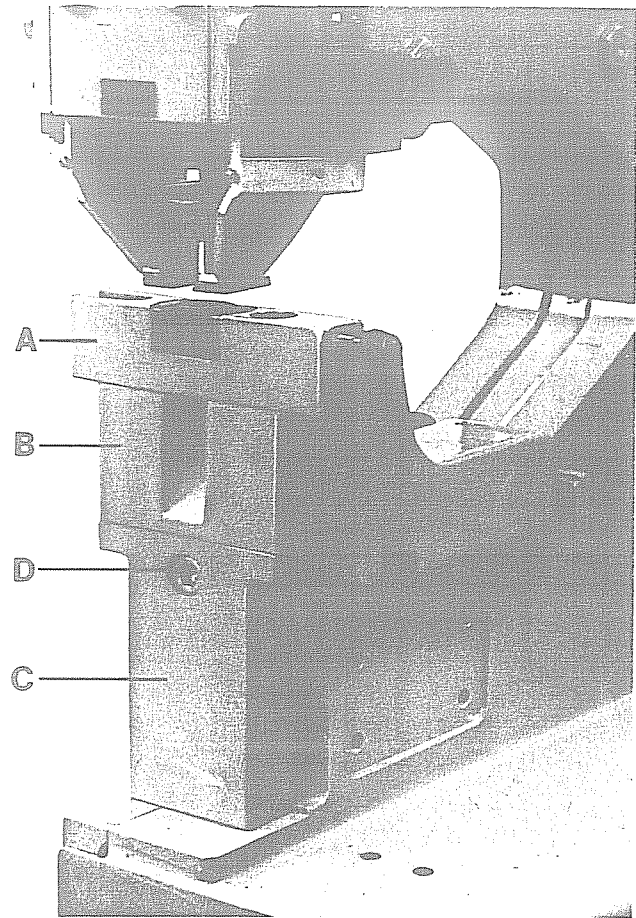

Fig. 57: Saddle with saddle support

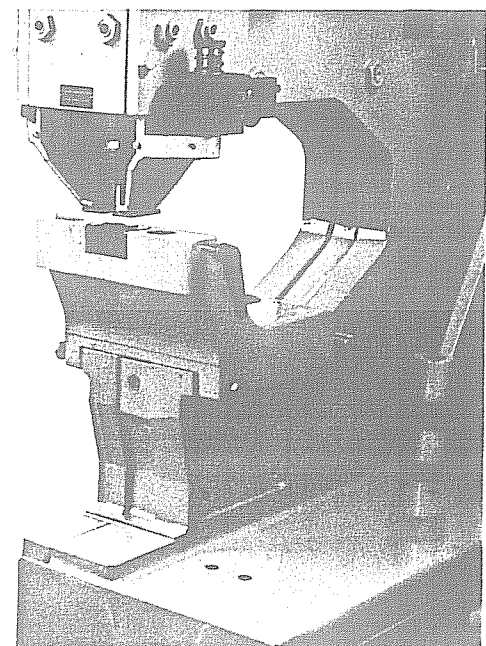

Fig. 58: Saddle without saddle support

Please ask for our detailed catalogue on MUBEA Standardized Punches and Dies.

5. Adjusting Punch and Die

Punches and dies must always be centric. The cutting clearance should be approx. 5 % of material thickness (i.e. for punching 10 mm thick material the diameter of the die bore is 1 mm larger than the diameter of the corresponding punch, and the cutting gap is 0.5 mm). Therefore, when ordering state thickness of material to be punched.

When the fastening screws "A" and the adjusting screws "B" have been loosened, the saddle can be pushed to the front or backwards. The adjusting screws "C" serve to fix the saddle laterally. When the punches and dies have accurately been adjusted, tighten the adjusting screws "C" and "B", as well as the saddle fastening screws "A". (Cf. fig. 61)

During the punching operations, inspect the position of the tools now and again. To do so, punch the punch step by step to and into the die. Repeat this procedure after every tool change.

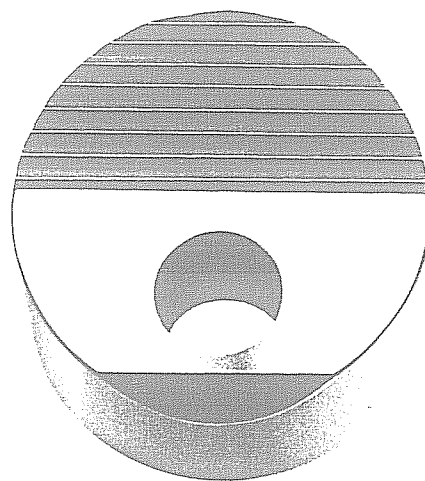

Fig. 59: Flansch die for I-beams

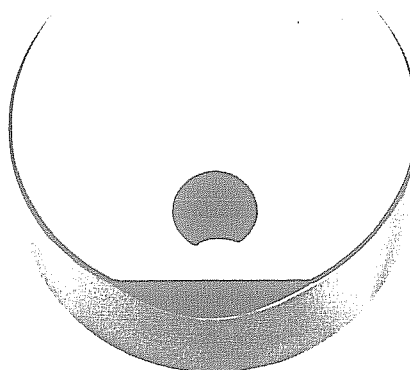

Fig. 60: Eccentric die for small angles

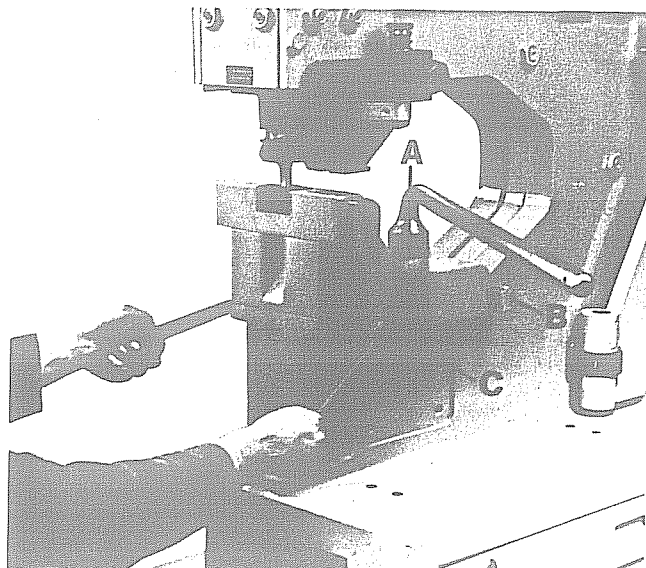

Fig. 61: Adjusting punch and die

Centred material can precisely be moved to in inching mode, by means of the built-in foot control, faulty punchings thus bein avoided.

6. Safety device to avoid twisting of Shaped Punches

Square, oblong or punches of other shape must be protected from being twisted. For this purpose, there is a groove on each punch holder on the surface fitting the punch, and on the front surface of each shaped punch.

Insert a centering pin of 4.7 mm dia. into this groove.

7. Stripper

The solid stripper covers the whole punching tool, and can be adjusted to any material thickness.

Hight-adjustment is done by means of the star grip "A" in the throat area. To change the tool, loosen both star grips "B", and shift stripper "C" into the throat area (See fig. 62).

For processing smaller sections and punching holes up to 15 mm diameter into material of small thickness, use the stripper reducing plate supplied.

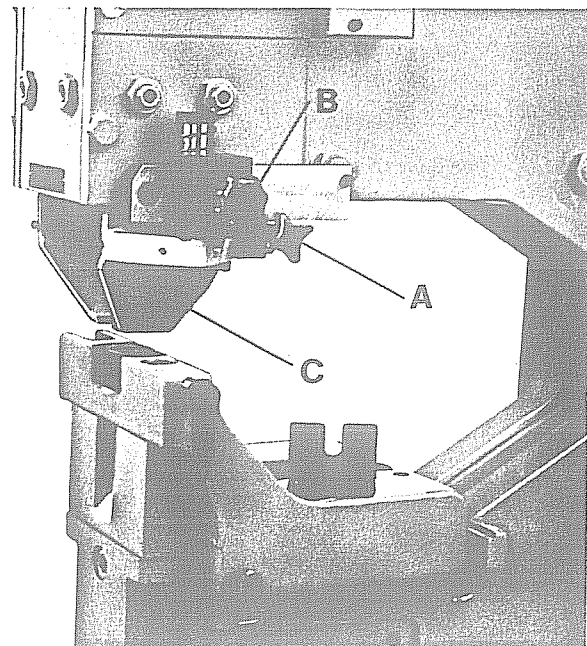

Fig. 62: Stripper

8. Regrinding Punching Tools

Regrind the punching tools on their front faces only, for otherwise the clearance between punch and die will be changed. To increase service life of the tools, grease the cutting edges now and again.

In many cases it is much easier and advisable to order new tools, for this will be more favourable, and guarantees correct grinding.

9. Quick-change Device for Punches and Dies

As standard, the machine is equipped with a quick-change device for round punches and dies. Both tool can easily and quickly be reset.

This device is most economical for small-lot production which requires frequent tool change.

Also shaped punches and dies can be used on this device, however, check the cutting clearance after every change, for often the saddle must be re-adjusted. In addition to this re-adjustment, as well as on installing the coupling nut, fasten the outer ring for the punch again after the first punching stroke, for the centering pin will have been pressed into the guide only after the first punching operation has been done.

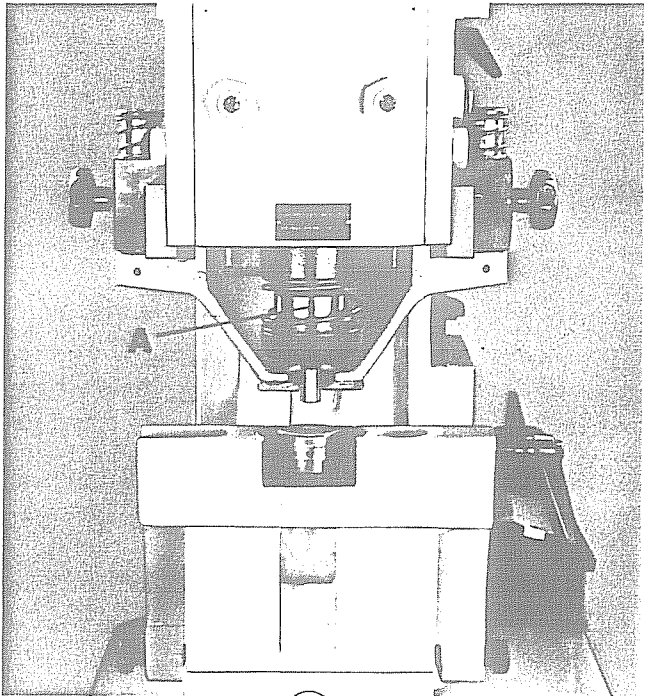

Fig. 63: Quick-change device for punches and dies

In case of processing larger series, it is advisable to use the more rugged punch-fastening device with coupling nut.

Reset the quick-change device for the coupling nut by loosening setscrew "A" (Fig. 63). The centering ring will be unblocked, and can be removed. After these few manipulations, the punch is ready for use of the coupling nut.

Assemble the quick-change device in reverse order.

If, for any reason, a punch cannot precisely be clamped, correct the basic position of the centering ring. To do so, loosen setscrew "A", slightly re-adjust the centering ring, and lock by means of the setscrew again.

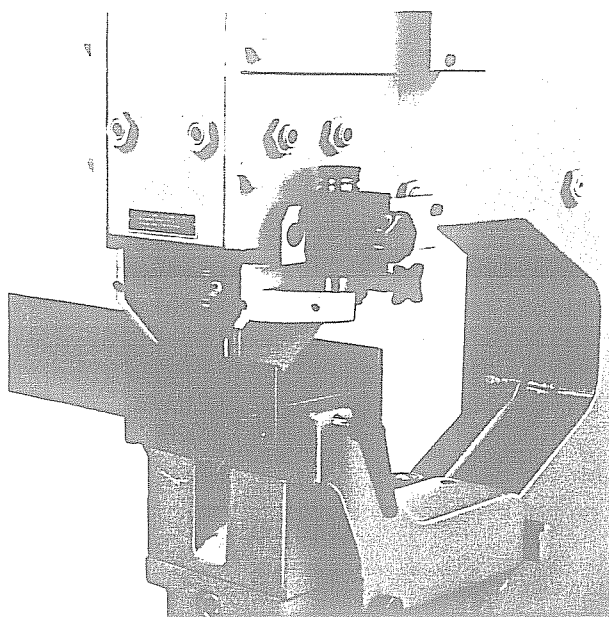

Fig. 64: Punching the web of I-beam

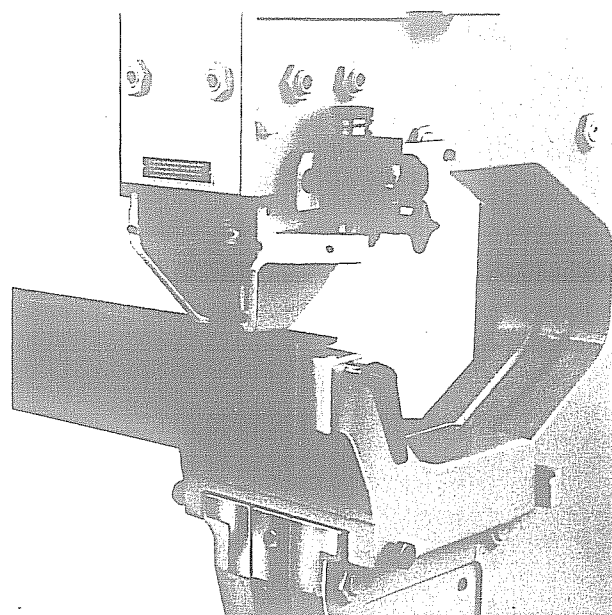
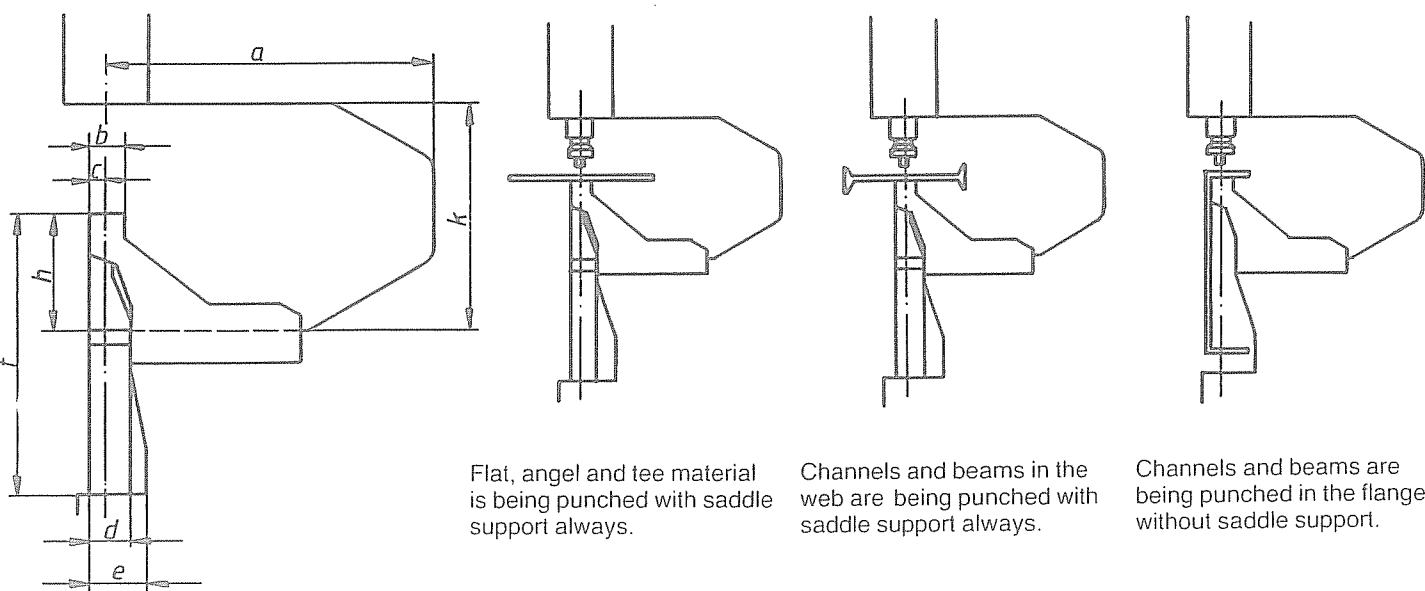

Fig. 65: Punching the flange of a channel



KBLH	300		500		700	
	mm	inch	mm	inch	mm	inch
a	320	12 ⁵ / ₈	410	16 ¹ / ₈	510	20 ¹ / ₁₆
b	47,5	1 ⁷ / ₈	47,5	1 ⁷ / ₈	47,5	1 ⁷ / ₈
c	22,5	⁷ / ₈	22,5	⁷ / ₈	22,5	⁷ / ₈
d	55,5	2 ³ / ₁₆	55,5	2 ³ / ₁₆	57,5	2 ¹ / ₄
e	74,5	2 ¹⁵ / ₁₆	74,5	2 ¹⁵ / ₁₆	82,5	3 ¹ / ₄
f	280	11	310	12 ³ / ₁₆	403	15 ⁷ / ₈
h	130	5 ¹ / ₈	130	5 ¹ / ₈	178	7
k	240	9 ⁷ / ₁₆	240	9 ⁷ / ₁₆	322	12 ¹¹ / ₁₆

Fig. 66: Dimensions of punch saddle KBLH

10. Special Tools

Due to the comprehensive standard MUBEA tool programme, all mostly required special tools are available at short notice. Furthermore, the special design of the MUBEA punch enables versatile application of special tools which, however, cannot be described as short summary.

a) Stationary Triple-Punch Tool

In case holes of different diameters are to be punched in short alternation, it will be advisable to use a triple-punch tool enabling punching holes of 3 different diameters in one stroke and without the need of removing tools. By pulling the adequate bar, the punch wanted will be set to its working position.

b) Adjustable Two-Punch Tool

This tool enables simultaneous punching of 2 holes of equal or different diameters, at different spacings. The distance desired can be learned from a scale, and is set by means of a handle, simultaneously for punches and dies.

When these adjusting manipulations have been done, any further setting operation is superfluous.

c) Special punching equipment for punches and dies of up to 50 mm diameter

This tool enables use of all punching tools, such as round, square, rectangular, and oblong tools.

The complete equipment comprises: M 64 punch holder, M 64 Union nut with 50 mm opening, insert with 40 mm opening, stripper, saddle 8 mm receptacle, 80/60 die holder, and saddle support.

The punches are clamped by means of a union nut. In principle, the shaped punches have a groove so that the tools can be used lengthwise or at right angle to the machine. When ordering tools, please specify thickness and tensile strength of the material to be processed.

d) Special punching equipment for punches and dies from 50.5 to 100 mm diameter (KBLH 300/500), and 50.5 to 150 mm diameter (KBLH 700) respectively

This tool, consisting of punch holder, stripper, saddle cap, saddle, and saddle support, enables installation of all kinds of punching tools, such as tools for punching round, square, rectangular and oblong holes.

When ordering shaped punches (oblong and rectangular) please state whether the tools will be used lengthwise or at right angle to the machine. Furthermore, generally state both thickness and tensile strength of the material to be punched. Fasten punches by means of a key.

MAINTENANCE PRESCRIPTIONS

for HYDRAULIC PLANT

A. General

For functioning and service life of the hydraulic plant it is extremely important to observe the following maintenance prescriptions.

B. Filling up the Oil Reservoir

Before starting oil level of the oil reservoir should be checked. The oil level shall be about 3 cm below the reservoir cover. Checking is performed by means of the gauge stick at the filling filter. Filling should be carried out only via the filter element. After filling, the filler has to be perfectly closed.

For filling the plant there has to be used only highgrade branded hydraulic oil. At medium ambient temperatures (5°C to 35°C) there should be employed H y d r a u l i c O i l H L P 46 (Viscosity classification: ISO VG 46 DIN 51 519). At extreme low or high temperature, the manufacturer should be consulted.

All reputable oil manufacturers supply suitable oils. As mixing of the hydraulic oil of various manufacturers is

not advisable, there should be always refilled the same type. The oil type of machines filled in the factory is stated on the oil reservoir.

C. Starting

At setting plant into operation there has by all means to be observed the correct direction of rotation of the motor. To avoid damages of the pump, the motor must start up in inching operation. The engagements should then not be actuated. When having ascertained the correct direction of rotation, the motor must be kept running for about 3 to 4 min. without actuating the engagements. To ensure escaping of the air eventually existing in the system, each cylinder has afterwards to be moved out and in repeatedly without loading over the whole stroke. After perfect venting the plant can be started up under load.

The max. operating pressure adjusted in the factory is specified on the reference plate at the oil reservoir. Checking of the pressure can be carried out by means of a manometer at the measuring connection above the oil reservoir.

The stated max. operating pressure should not be exceeded.

D. Maintenance

Current checking of the oil level in the oil reservoir is necessary in order to avoid greater damages.

After approx. 10 operating hours the return filter fixed on the oil reservoir has to be cleaned for the first time. Cleaning should be done in rinsing oil or petroleum.

Throw-away filter cartridges have to be replaced. After having fitted the clean resp. new filter element the plant is again ready for work. Further filter cleaning should be done at normal fouling about every 600 operating hours.

The first oil change should be carried out after approx. 600 operating hours. Afterwards the oil has to be renewed every 1 200 to 1 500 operating hours. After draining of the waste oil, the oil reservoir and the whole system have to be cleaned with rinsing oil. Water, leaches and petroleum are not suitable as purifying agents. After complete cleaning the plant has to be closed and to be

filled up with new, unused hydraulic oil. All filters have to be cleaned at every oil change. Of course, there has to be taken care of greatest cleanliness when refilling.

During operation there have to be permanently controlled the oil level, the leakage of the plant, the fastening of the units and pipes as well as state of the hydraulic oil and the filters.

E. Eliminating troubles

Fault 1: Excessive noise in the plant

Cause	Reason	Elimination
1.1 Cavitation in the pump	1.1.1 Hydraulic oil too cold (below + 5°C)	Heat the hydraulic oil to the temperature of + 5°C
	1.1.2 Viscosity of the hydraulic oil is too high	Replace the hydraulic oil by a suitable one (see section "Filling up the Oil Reservoir")
	1.1.3 Steam generation	The max. oil temperature of + 70°C is exceeded. Refill hydraulic oil or replace it by prescribed one
	1.1.4 Failure of the pump	Exchange the pump
	1.1.5 Sealed reservoir	Clean vent-filter in the cover of the filler
1.2 Foam formation or air pockets in the pressure fluid	1.2.1 Pressure fluid level in the reservoir is too low	Fill up on the correct level
	1.2.2 Wrong hydraulic oil	Replace by suitable oil
	1.2.3 Entering of air caused by the screwed joints in the suction pipe	Retighten or replace the screwed joints
1.3 Mechanical vibrations	1.3.1 Vibrations of the pipings	Retighten the attachments
1.3.1 Pump	1.3.1.1 Used up or damaged	Replace
1.3.2 Drive motor	1.3.2.1 Used up or damaged	Repair or replace
1.3.3 Safety or pressure limiting valve	1.3.3.1 Flatters	Adjust correctly or replace

Fault 2: No pressure or insufficient pressure

Cause	Reason	Elimination
2.1 Pump does not feed correctly	2.1.1 Air enters into the suction pipe	See 1.2.3
2.2 High pump temperature	2.2.1 Used up or damaged pump	Replace the pump
	2.2.2 Unsufficient viscosity of the hydraulic oil	See 1.1.3
2.3 Leakage losses of the pressure side in the return motion	2.3.1 Mechanic control valve not connected through	Reset limitations of the engaging path
	2.3.2 Wrong adjustment of the pressure	Correct the adjustment
	2.3.3 Safety valve does not shut as there are dirt and defective parts	Clean, ascertain the damage, replace or renew
	2.3.4 Way valve open as there are dirt or defective parts electric fault	Clean the damaged unit, repair or replace
	2.3.5 Damaged cylinder bore, piston rod or piston seal	Renew the damaged parts
2.4 Failure of the pump	2.4.1 Damaged pump, defective drive, unsuitable viscosity of the liquid, etc.	See faults 1.3.1.1, 1.1.2

Fault 3: Anomalous pressure or flow fluctuations and vibrations

Cause	Reason	Elimination
3.1 Cavitation in the pump	3.1.1 See faults 1.1.1 to 1.1.5	See faults 1.1.1 to 1.1.5
3.2 Foam formation or air pockets in the liquid	3.2.1 See faults 1.2.1 to 1.2.3	See faults 1.2.1 to 1.2.3
3.3 Mechanic vibrations	3.3.1 See faults 1.3.1	See faults 1.3.1
3.4 Flattering pressure limiting or safety valves	3.4.1 See faults 1.3.3.1	See faults 1.3.3.1
	3.4.2 Damaged valve seat	Repair or renew
3.5 Valves seize	3.5.1 Fouling	Drain the hydraulic oil, clean plant and parts, fill up with clean oil
	3.5.2 Defective or distorted	Replace the unit, eliminate distortion
3.6 Air pockets in the plant which cause irregular or yielding motion	3.6.1 Plant is not completely vented	Vent the plant (see section "Starting")
	3.6.2 Electric equipment defective	Trace and eliminate the error

Fault 4: Uninsufficient or no feed current

Cause	Reason	Elimination
4.1 Cavitation in the pump	4.1.1 See faults 1.1.1 to 1.1.5	See faults 1.1.1 to 1.1.5
4.2 Foam formation or air pockets in the pressure liquid	4.2.1 See faults 1.2.1 to 1.2.3	See faults 1.2.1 to 1.2.3
4.3 Used up pump	4.3.1 See faults 1.1.4	See faults 1.1.4
4.4 Leak losses from the pressure side in the return motion	4.4.1 See faults 2.3.1 to 2.3.5	See faults 2.3.1 to 2.3.5
4.5 Pump rotates in the wrong direction	4.5.1 Wrong direction of rotation of the motor	Reverse polarity of the electric connections

Fault 5: Too high temperature of the pressure fluid

Cause	Reason	Elimination
5.1 Overflow losses	5.1.1 Pressure adjustment too high	Correct the adjustment
5.2 Leak losses from the pressure side in the return motion	5.2.1 Bad functioning of the valves and defective seals	See faults 2.3.1 to 2.3.5
	5.2.2 Wrong viscosity of the hydraulic oil (too low, too high)	Drain the hydraulic oil and use the prescribed oil
5.3 Overheated pump	5.3.1 Wear of the pump	Replace the pump
5.4 Too quick circulation of the pressure fluid	5.4.1 Pressure fluid level has become too low in the plant	Filling up of the plant on the prescribed level (see section "Filling up the Oil Reservoir")

Schmierstoffe, Lubrikant, Lubrifiant
 MOBIL OIL AG VACTRA Oil Nr. 4
 Viskosität 125 mm²/s bei 50 °C
 ESSO AG MILLCOT K 220
 Viskosität 120 mm²/s bei 50 °C
 BP Energol HP C 220
 Viskosität 127 mm²/s bei 50 °C
 ARAL Degolint B 220
 Viskosität 130 mm²/s bei 50 °C
 SHELL Tonna Oil T 220
 Viskosität 128 mm²/s bei 50 °C

For machines supplied to the USA

Lubrifiant
 CHEVRON VISTAC OIL 150X

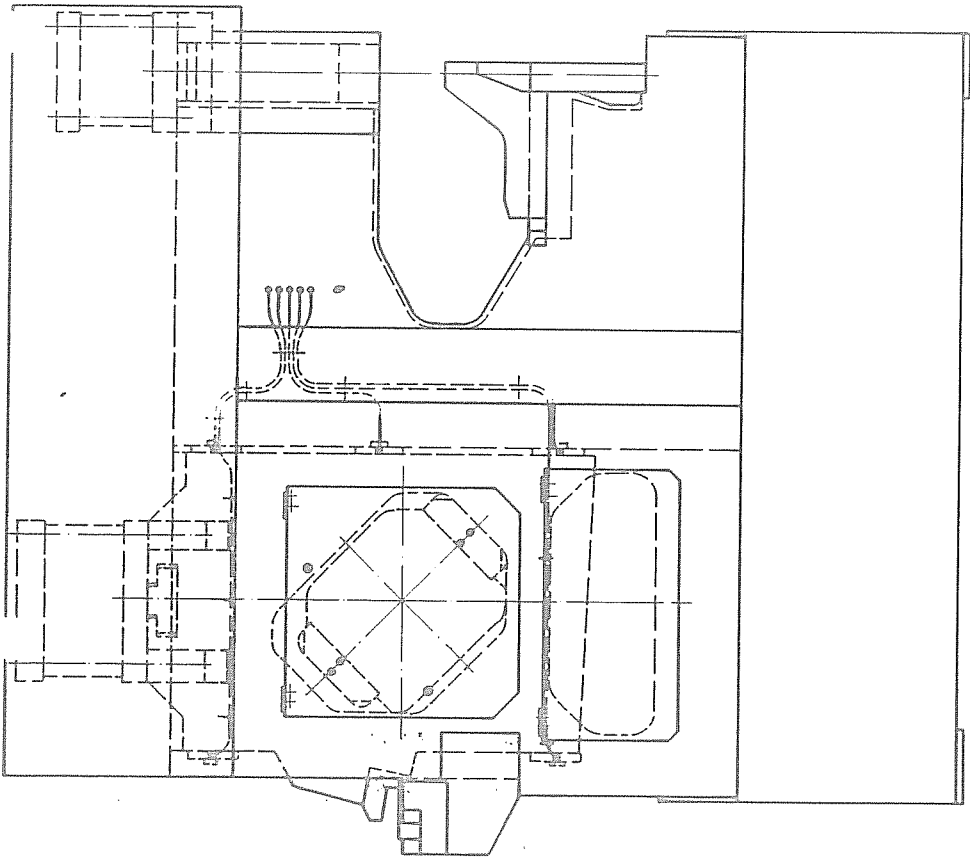

Alle Schmierstellen sind an der Maschine gelb gekennzeichnet.
 All oiling points are yellow marked
 Tous les points de graissage sur la machine sont marqués en jaune

Vor Schichtbeginn und nachfolgend im Abstand von 5 Stunden je Schmierstelle 1 Pumpenhub mittels mitgelieferter Handstoffpresse!

Prior to starting the work shift and following in intervals of five hours lubricate each oiling point applying one pump stroke with the oil gun supplied with the machine

Lubrification exigée au début des travaux et après en intervalles de 5 heures chaque point de graissage par un coup de pompe de graissage manuelle livrée avec la machine

Benennung	3
Schmierplan	
Lubrication chart	
Plan de Lubrification	
Ziehungs-Nr.	01560 103 01
Blatt	
Blatt	
Ers. d.	

KBLH 500

	01560	01561
	mm	inch
A	1400	55 ¹ / ₁₆
B	1250	49 ³ / ₁₆
C	1770	69 ⁵ / ₈
D	965	37 ¹⁵ / ₁₆
E	700	27 ⁹ / ₁₆
F	1075	42 ⁵ / ₁₆
G	1099	43 ¹ / ₄
H	1450	57 ¹ / ₁₆
J	650	25 ⁹ / ₁₆
K	950	37 ³ / ₈
L	70	2 ³ / ₄
M	700	27 ⁹ / ₁₆
N	60	2 ³ / ₈
O	100	3 ¹⁵ / ₁₆

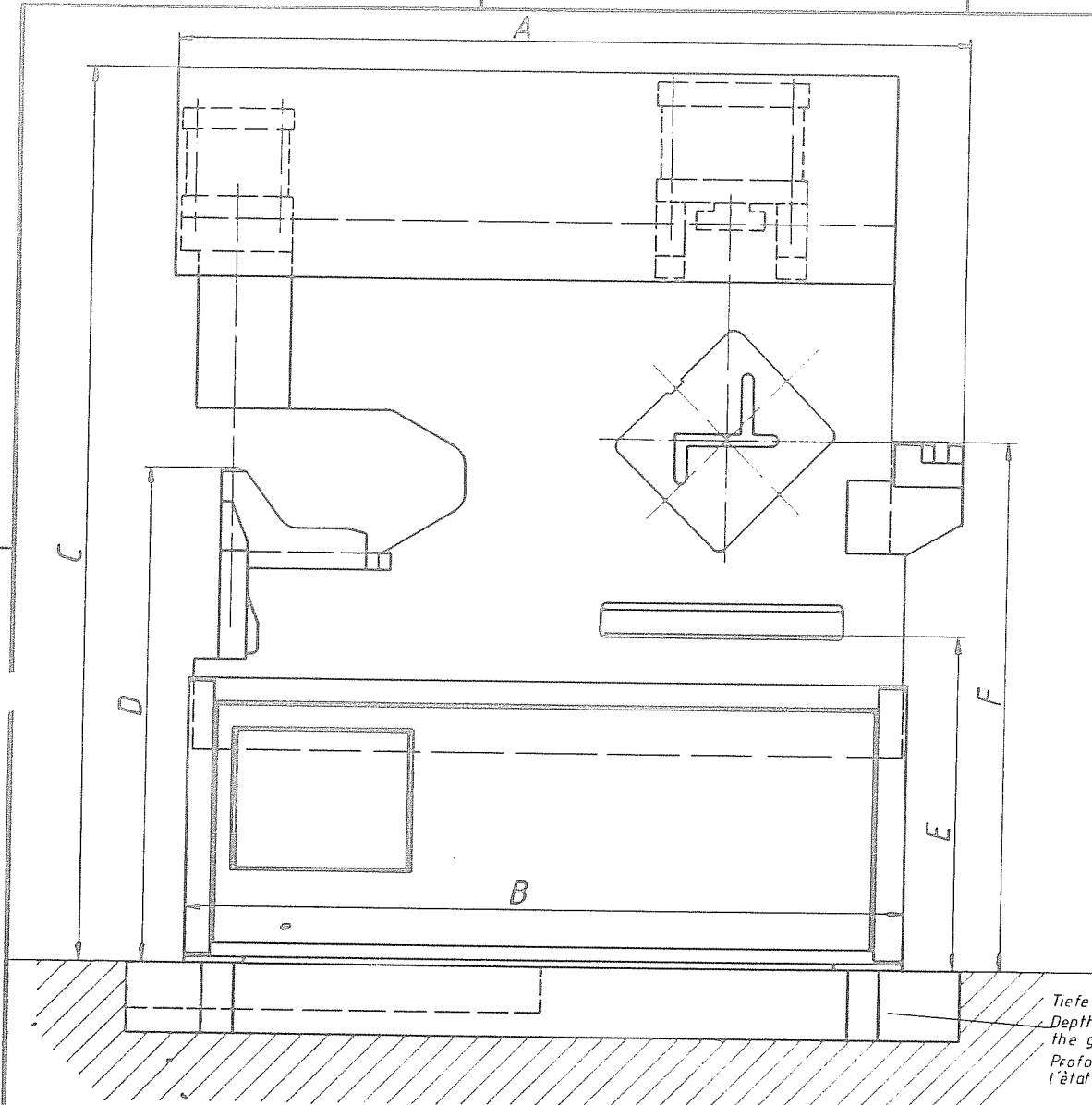

Tiefe je nach Bodenbeschaffenheit
 Depth according to the condition of the ground
 Profondeur de la fondation d'après l'état du sol

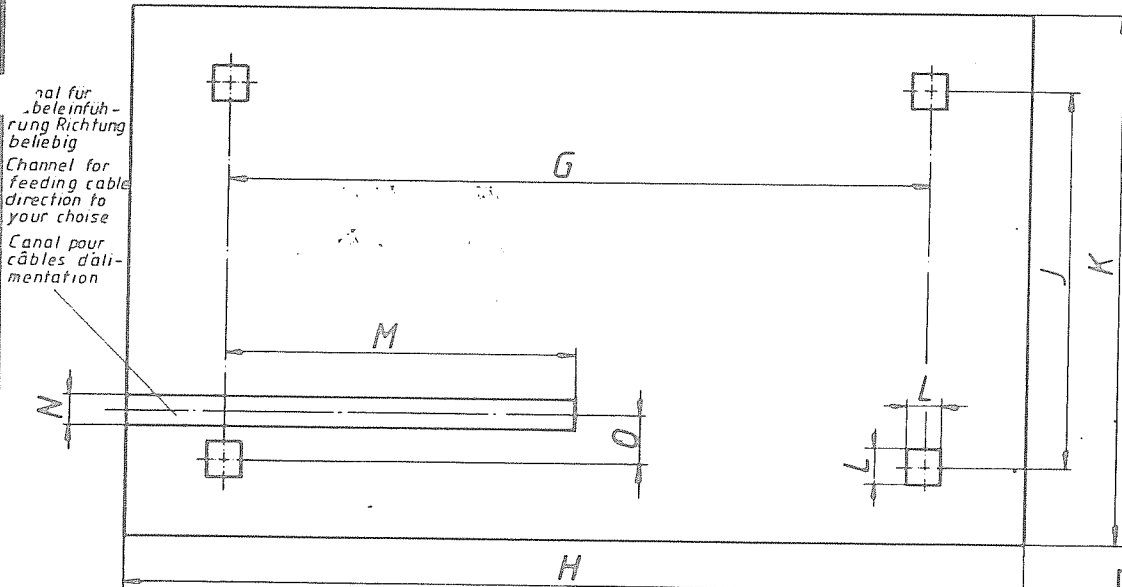

kanal für
 -beleinfüh-
 rung Richtung
 beliebig
 Channel for
 feeding cable
 direction to
 your choice
 Canal pour
 câbles d'ali-
 mentation

KBLH 500
 01560 103 02
 Fundamentplan
 Foundation drawing
 Plan de fondation